

AD-4405

AD-4407

OP-03/05/07

INSTRUCTION MANUAL

Weighing Indicator



A&D Company, Limited

WM:PD4000504-01 b



Contents

1. Compliance	4
1.1.1. Compliance with FCC Rules.....	4
1.1.2. Compliance with European Directive.....	4
2. Introduction	5
3. Installation and Precautions	6
3.1.1. Installation and Precautions.....	6
3.1.2. The Load Cell Connections.....	6
3.1.3. Adjustment of the Load Cell Output.....	7
3.1.4. Verifying Load Cell Output and Input Sensitivity.....	7
4. Description of Panels and symbols	8
4.1.1. Front Panel Description.....	8
4.1.2. Rear Panel Description.....	9
4.1.3. Other Displays and Symbols.....	9
4.1.4. Accessories.....	9
5. Calibration	10
5.1.1. Items of Calibration Mode.....	10
5.2. Calibration Procedure	11
5.2.1. Setting a weighing unit.....	11
5.2.2. Setting of range and unit.....	12
5.2.3. Setting resolution, decimal point and display format.....	12
5.2.4. Setting of Capacity of First Range.....	13
5.2.5. Setting of resolution of second range.....	13
5.2.6. Setting capacity of the second range.....	13
5.2.7. Preparation.....	13
5.2.8. Zero Calibration.....	14
5.2.9. Span Calibration.....	14
5.2.10. Exiting the Calibration Mode.....	15
5.3. Weighing Range Function	16
5.3.1. Setting Division and Range.....	17
5.4. Digital Linearization Function	17
5.5. Gravity Compensation Function	18
5.5.1. The Gravity Acceleration Table.....	19
5.6. Calibration Error Code List	20

6. Functions	21
6.1. Changing the Function Settings	21
6.2. F-Functions	22
6.3. CF-Functions	30
7. Tare	31
7.1.1. Weighing Tare.....	31
7.1.2. Digital Input.....	31
7.1.3. Clearing Tare	31
8. Accumulation	32
8.1.1. Preparation and Specification.....	32
8.1.2. Display and Operation	33
9. Memory Code	35
9.1.1. Using Memory Code	35
10. Comparison	36
10.1. Weight Check Mode	36
10.1.1. Condition formula for Comparison.....	37
10.1.2. Setting Upper/Lower Limit Values	37
10.1.3. Setting Order and Display for Weight Check Mode.....	38
10.2. Setpoint Comparison.....	39
10.2.1. Description of Input parameters and Outputs (F22 = 11).....	39
10.2.2. Setting the Parameters of Setpoint Comparison.....	39
10.2.3. Setting Order and Display for Setpoint Comparison and Simple batch.....	40
11. Counting Function	41
11.1. Using Counting Function	41
11.2. Unit Weight Registration	41
12. RS-232C Interface	43
12.1. Specification	43
12.2. Data Output Mode	44
12.3. Data Format	45
12.4. Command Format.....	45
12.4.1. Command to Request Data	46
12.4.2. Commands to Control the Indicator.....	47
12.4.3. Commands to Set Parameters.....	48
12.4.4. Commands to Set Data Output/ Print Format (UFC)	49

12.5. UFC Command Parameter 50

13. *Calendar / Clock (AD-4405 only)* 51

13.1. Time and Date Functions 51

13.2. Setting Time and Date 52

14. *Specifications* 54

14.1. Dimensions 55



1. Compliance

1.1.1. Compliance with FCC Rules

Please note that this equipment generates, uses and can radiate radio frequency energy. This equipment has been tested and has been found to comply with the limits of a Class A computing device pursuant to Subpart J of Part 15 of FCC rules. These rules are designed to provide reasonable protection against interference when this equipment is operated in a commercial environment. If this unit is operated in a residential area it may cause some interference and under these circumstances the user would be required to take, at his own expense, whatever measures are necessary to eliminate the interference.

(FCC = Federal Communications Commission in the U.S.A.)

1.1.2. Compliance with European Directive

CE This appliance complies with the statutory EMC (Electromagnetic Compatibility) directive 89/336/EEC and the Low Voltage Directive 73/23/EEC for safety of electrical equipment designed for certain voltages.

Note: The displayed value may be adversely affected under extreme electromagnetic influences.



2. Introduction

- AD-4405/07 is a weighing indicator that amplifies signals from load cell, converts it to digital data and displays it as a mass value.
 - **0** – **9** keys enables easy operation, such as setting of comparator values.
 - Built-in calendar clock with battery backup AD-4405 only
 - Printer with dot matrix could be installed(OP-06) AD-4405 only
 - IP-67 dust&water-proof stainless housing AD-4407 only
- This indicator has the following performance:
 - Input sensitivity:.....0.2 μ V/division.
 - Maximum display:.....20000 divisions.
 - Refresh rate of the display: 10 times/second approximately.
 - Input voltage range:-1 mV ~ +15 mV.
- There are the following standard functions:
 - The HiHi/Hi/OK/Lo/LoLo limit comparison to check a mass value.
 - The setpoint comparison for batching applications.
 - The counting function for piece counting.
 - Preset tare function.
 - There are four memory codes to be stored above mentioned data.
 - The accumulation function to totalize these mass values and to count the number of accumulations.
 - UFC(Universal Flex Coms) function to customize the protocol of the printing format as well as outputting data with serial interface.
- There are the following interfaces:
 - RS-232C(as standard) serial interface to communicate with a computer, printer or remote display. This computer interface can request weighing data, enter parameters and control the state of the indicator.
 - RS-422/485 network interface
 - RS-232C, Relay Output and Control Input
 - Analog Output (4-20mA)One interface can be installed at the same time.
- The calibration function includes the following functions:
 - Setting of the minimum division (weighing interval) and the maximum capacity.
 - Zero and span calibration.
 - The weighing range function of the multi-interval weighing instrument (scale).
 - Digital linearization function.
 - Gravity compensation function.



3. Installation and Precautions

3.1.1. Installation and Precautions

- AD-4405/07 weighing indicator is a precision electronic instrument. Handle the indicator carefully.
- The operating temperature is -10°C to +40°C (14°F to 104°F).
- Do not install the scale in direct sunlight.
- Misoperation or other problems may be caused by an unstable power source including momentary power failure or instantaneous noise. Use a stable power source.
- ⚠ □ Do not connect the power cord before the installation is completed.
- ⚠ □ The local voltage and receptacle type are correct for your scale.
 - Use shielded cable for all connections. Connect the cable shields to the shield terminal or case as an earth terminal.
 - Earth ground the indicator. Do not join the earth ground line with other electric power equipment. There is an earth ground terminal at the power cord receptacle.
 - Do not install the scale in a place where it is apt to be charged with static electricity, or where the relative humidity is lower than 85%RH. Plastic and isolators are apt to be charged with static electricity.

3.1.2. The Load Cell Connections

- Connect the load cell wires to the connector (receptacle), at the rear panel, using the accessory load cell plug for AD-4405 and connect the loadcell cable to the terminal for AD-4407. Pin Numbers are used as same as AD-4405.
- It is possible to connect a 4 wire cable that 1pin-2pin and 3pin-4pin are shorted, if the distance between the indicator and a load cell is shorter than 5m.
- The output voltage of a load cell is a very sensitive signal. Space the load cell cable away from any noise source.
- It is possible to connect four 350ohm load cells for AD-4405 and eight 350ohm load cells for AD-4407.

The load cell drive is 5VDC \pm 5% between EXC+ and EXC-, the maximum current 60mA for AD-4405 and 120mA for AD-4407.

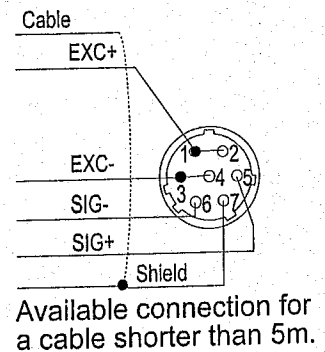
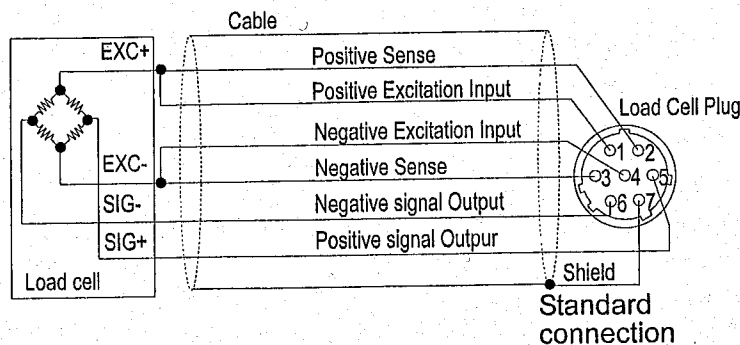

3.1.3. Adjustment of the Load Cell Output

Caution □ Use a metal film resistor in the range of 50kohm to 500kohm with a good temperature coefficient, when adding a resistor to adjust a load cell output. Use as a large resistance value as possible in the range in which zero adjustment is possible. Solder this resistor at a point near the load cell or the indicator.

In Case of Reducing the Output Voltage

When the zero output is too large, add a resistor between EXC+ and SIG-.

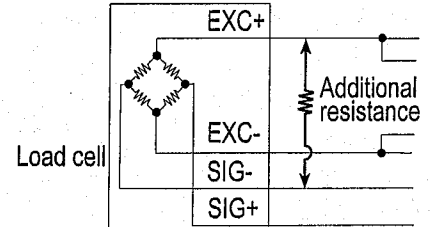

In Case of Adding an Offset Voltage to the Output

When the zero output is too small, add a resistor between EXC+ and SIG+.

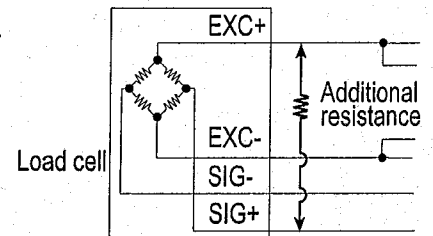

3.1.4. Verifying Load Cell Output and Input Sensitivity

The input sensitivity of the indicator is 0.2µV /division or more. Adapt to the following inequality, when you design a weighing instrument using the indicator and load cell(s).

Caution □ **A change in input voltage sensitivity is equivalent to a one division change of the display. Select as large an input voltage sensitivity voltage as possible so that the weighing interval becomes stable.**

□ Consider the leverage if a lever is used.

Weighing instrument using one load cell.	$0.2 \leq \frac{E * B * D}{A}$	A: Rated capacity of load cell [kg] B: Rated output [mV/V] D: Weighing interval [kg]
Weighing instrument using multi-load cell	$0.2 \leq \frac{E * B * D}{A * N}$	E: Excitation voltage [mV] N: Number of load cells

Verification Example

Design:		
Load cell	N=1	
Rated capacity	A=750 [kg]	$\frac{5000 * 3 * 0.05}{750} = 1 \geq 0.2$. Therefore, regard the instrument as a good design.
Rated output	B=3 [mV/V]	
Excitation voltage	E=5000 [mV]	
Weighing interval	D=0.05 [kg]	
Weighing capacity	300 [kg]	



4. Description of Panels and symbols

4.1.1. Front Panel Description

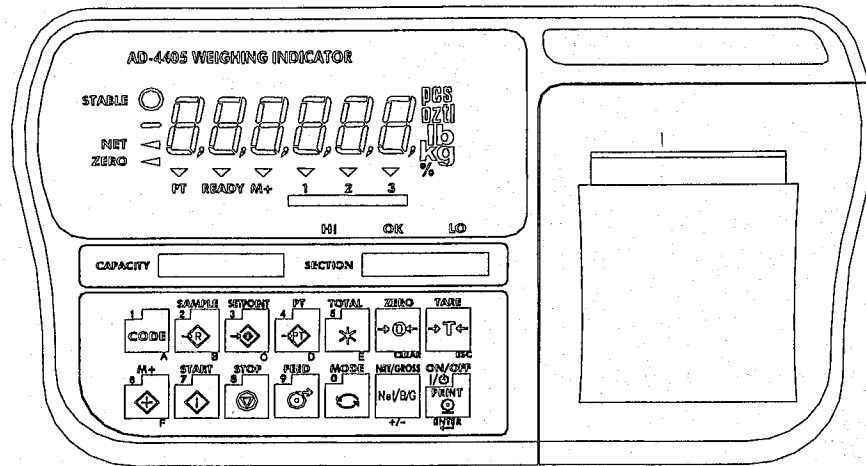

Name	Description
STABLE	Lights when display is stable
NET	Lights when the weight is net weight
ZERO	Lights when display weight is in the Zero range
UNIT part	Unit used to weigh
PT	Lights when PRESET TARE value is being used.
READY	Tells state of comparison or batching
M+ (Accumulation)	When there is result of addition or accumulation
1,2,3(Triangle mark)	Indicates various status, depending on the selected function.
HI/OK/LO	Tells results of comparison or state of batching
CODE key	Selects code memory
SAMPLE key	Sets unit weight for counting function.
SETPOINT key	Sets comparator value.
PT key	Sets PRESET TARE
TOTAL key	Displays total weight.
M+ key	Displays total weight.
START key	Starts comparison/batching
STOP key	Stops comparison/emergency stop of batching.
FEED key	Feeds Paper of optional Built-in Printer (AD-4405)
MODE key	Switches unit
0 – 9 key	Uses to input any numerical setting
A – F key	Uses to enter setting value
ZERO key	Memorizes current quantity as zero point and displays as zero
CLEAR key	Clears setting value
TARE key	The key to perform tare.
ESC key	Proceed to the next step without memorizing the data set
NET/GROSS key	The key to selectg net or gross weight in the display

+/- key	The key to select + or – of a value
ENTER key	Fix settings and memorizes the value
PRINT key	Prints/outputs data (press instantly)
ON/OFF key	Turns on and off the unit

Printer	Internal dot matrix printer (optional) AD-4405 only
---------	---

4.1.2. Rear Panel Description

Name	Description
Power cable	Please Confirm that the local voltage and receptacle type are correct for your scale.
Grounding terminal	
CAL switch cover	CAL switch allocated inside the panel. (AD-4407)
Sealing panel	For type approval, CAL switch is inside the panel (AD-4405)
Load cell connector	Connect accessory load cell. (AD-4405)
RS-232C connector	Terminal block is inside the case (AD-4407)

4.1.3. Other Displays and Symbols

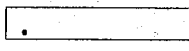
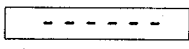
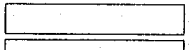
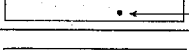
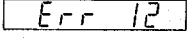
	Standby display.
	Zero error when turning display on. If the ESC key is pressed, a current weighing value may be displayed.
 Blank  Decimal point	Over load display. Remove any load from the load cell immediately. It may cause damage to the indicator.
	Example of an error display.

4.1.4. Accessories

Accessories	Instruction manual	1	
	Load cell plug (AD-4405)	1	JM-NJC-207-PF
	0.2A or 0.315A time lag fuse	1	FS-EAWK-200MA FS-EAWK-315MA
	Blanket (AD-4407)	1	

Caution Please Confirm that the receptacle type and local voltage is correct for your indicator (scale).



5. Calibration

This weighing indicator, converts an input voltage from a load cell to the "mass" value, and displays it. Calibration is the adjustment function so that the scale (indicator) can weigh correctly.

5.1.1. Items of Calibration Mode

There are four items in the calibration function where setting should be done.

How to calibrate: In weighing mode, press CAL key. After **CAL in** is displayed for 2 seconds **CAL 0** will appear. Then required items should be selected and displayed with **MODE** key, then executed by pressing **ENTER** key.

NOTE: Calibration could be started by simultaneously pressing **ZERO** key with **TARE** key, instead of CAL key. However, in some cases, settings are altered to nullify this option. Furthermore, this option is not available with Stamping type version setting.

Required Items

CALSet Setting capacity, resolution, alignment of decimal point or display format, unit and weighing range. This item should be firstly set in order for the unit to function as a weighing device. Set values don't need to be changed again unless weighing unit itself is replaced. To set this item, refer to 5.2.1. Setting as a weighing device.

CAL 0 Calibrates zero and span. To get accurate data it is necessary and must be done when installing. To set this item, refer to 5.2.6. Zero Calibration and 5.2.7. Span Calibration

Optional Items (Sub-functions)

Lnr 0 Does digital linealization. Refer to 5.4. Digital Linealization

G Set The function to revise weighing error between the calibration location and another weighing location using gravity acceleration. Refer to 5.5. Gravity Compensation Function.

In calibration mode keys have each function as follows:

0 - 9 Sets numerical values

MODE Used to alter items for setting, etc.

CLEAR When setting values, set initial value. In other modes, changes the setting

+/- Changes settings

ESC Proceed to the next step without changing set value.

ENTER Memorizes the set value and precedethe next step.

CAL Writes all the set data into memory and displays CALoFF after which the calibration mode is off with **ON/OFF** key.

Note that **ON/OFF** does not function alone. Press **ESC** while holding **ON/OFF** to end the calibration mode when value is mistakenly set. After **CAnSEL** is displayed pressing **ON/OFF** stops calibration mode and turn the unit off.

NOTE: **CALoFF** could be displayed by pressing **+/-** key while pressing **ON/OFF** key, instead of **CAL** key. However, in some cases, settings are altered to nullify this option.

- Caution**
- **The maximum display is less than or equal to 20000 divisions. This number is calculated from the maximum capacity divided by the minimum division.**
 - **Check the accuracy of weighing instrument periodically.**
 - **Recommended mass, use a mass heavier than 2/3 maximum capacity.**
 - **Calibrate the scale, if it is moved to another location or the environment has changed.**
 - **It is not necessary to set the gravity acceleration correction, when calibrating the scale with a calibration mass at the place where the scale is used.**
 - **Enter the stable weighing data while the STABLE mark is turned on. If unstable data is used, it may cause a weighing error. Arrange the condition using the F00 filter function.**
 - **The span calibration needs the zero calibration data. We recommend that you perform the span calibration immediately after the zero calibration.**
 - **If you use the dual or triple range function of the multi-interval scale, perform the "Range Function", "Zero Calibration" and "Span Calibration".**



5.2. Calibration Procedure

5.2.1. Setting a weighing unit

In this section, how to set capacity, resolution, alignment of decimal point or display format, unit and weighing range is described. When installing, these items must be set.

When **CALSet** appears on the display, enter setting mode with a pressing of **ENTER** key.

Setting of range function and unit

Single Range

Set resolution and alignment of decimal point



Set weighing capacity

Dual Range



<First range> Set resolution, place and format of decimal point.



<First range> Set weighing range



<Second range> Set resolution



<Second Range> Set capacity

For range function, refer to 5.3. Weighing Range Function.

5.2.2. Setting of range and unit

Step 1 The range is displayed in the main display and the unit set, unit display area.

Range display : SinGL : single range

dUAL : dual range

To change the range function with **CLEAR** key

Unit display: Unit usable is lit. Units that can be used interchangeably such as kg or lb calibration would be done by the unit displayed.

To select usable unit use **MODE** key and unit for calibration use **+/-** key. Unit for calibration(first unit) is lit and the alter unit(second unit) is flashed.

ENTER Memorizes the value displayed and precede the next step.

ESC Proceed to the next step without changing set value.

5.2.3. Setting resolution, decimal point and display format

Step 2 Resolution will be displayed as d 0.01, with decimal point. Triangle 1 and the first unit determined at previous step will light.

Positioning of decimal point could be done with **CLEAR** key, setting of display format(point or comma) with **+/-** key, resolution with **MODE** key. Display format of decimal point, set at this stage, will only apply to display. Decimal point for serial data output could be selected from F-function settings.

Press **ENTER** to memorize displayed settings and proceeds to the next step. With **ESC** key, regardless of what is displayed, proceed to the next step without changing the set data.

5.2.4. Setting of Capacity of First Range

Step 3 Setting of capacity or first range where single range is applied, capacity will appear after displaying **CAP** for about 2 seconds. Where dual range, the first range will appear after displaying **CAP1** for about 2 seconds. Triangle 1 will be displayed. Set value with **0** – **9** key and **ENTER** that memorizes the value displayed and proceeds to the next step. With **ESC** key, regardless of what is displayed, proceed to the next step without changing the set data. The next step in single range is zero calibration and in dual range, setting of resolution of the second range.

5.2.5. Setting of resolution of second range

Step 4 After displaying **rAnGE2** for 2 seconds, resolution with decimal point for instance 0.02 will be displayed. Also, since it indicates in the first range, triangle signal 2 will light. Setting the second range resolution is just like when setting one of the first range but decimal point cannot be moved and value bigger than the one of the first range. With a press of **ENTER**, settings displayed are memorized and proceed to the next step (5.2.6). With **ESC** key, regardless of what is displayed, proceed to the next step without changing the set data.

5.2.6. Setting capacity of the second range

Step 5 Capacity with unit and decimal point will automatically appear on the display after displaying **CAP2** for 2 seconds. Set the capacity just like when setting one of the first range but the value should be bigger than the one of the first range, otherwise, it is recognized as an error. With **ENTER** key, setting displayed is memorized and proceed to zero calibration.

5.2.7. Preparation

Step 6 Keep the following conditions to calibrate the scale (indicator) correctly.

- Maintain a constant temperature, stable power and stable input voltage from the load cell.
- Avoid direct sunshine and in the neighborhood of an air conditioner.
- Do not install the scale (indicator) where there is a strong magnetic field.

Step 7 Turn the display on during 10 minutes.

5.2.8. Zero Calibration

Procedure

Step 8 Check the **CAL 0** display.

Select a zero calibration method to adjust the zero point

Weighing input (Normal way)	The adjustment method with nothing on the weighing unit.	To step 9
Digital input	The numerical input to enter a load cell output voltage.	To step 10

Weighing Input

Step 9 Place nothing on the weighing unit. Press the **ENTER** key after the STABLE mark has turned ON. Proceed to step 11.

ESC key The key not to change the zero point data and proceed to the next step.

Caution Do not press the **ENTER key while the STABLE mark is off (detecting motion). Arrange the condition using the F00 filter function.**

Digital Input

Step 10 Pressing the **+/-** key, a stored input voltage parameter of the zero point is displayed in the unit of mV/V. Adjust the input voltage using **0** - **9** keys.

ENTER The key to store the zero point parameter and proceed to the next step.

ESC key The key not to change parameter and proceed to the next step.

5.2.9. Span Calibration

Step 11 Check the capacity display after **CAL F** display for 2 seconds.

Select a span calibration method to adjust the capacity.

Weighing a mass except the maximum capacity	The method to weigh a mass except the maximum capacity.	To step 12
Weighing maximum capacity	The method to weigh a mass equivalent to the maximum capacity.	To step 14
Digital input	The numerical input to enter a load cell output voltage.	To step 16

Weighing a Mass except the Maximum Capacity

Step 12 Set a mass value using **0** - **9** keys.

Step 13 Place a mass equivalent to displayed value on the weighing unit. Proceed to step 15.

Weighing Capacity Mass

Step14 Place a mass equivalent to the maximum capacity on weighing unit.

Step15 Press the **ENTER** key after the STABLE mark turns on. Proceed to the next step.

ESC key The key not to change span data and proceed to the next step.

Caution Do not press the ENTER key while the STABLE mark is off (detecting motion). Arrange the condition using the F00 filter function.

Digital Input

Step16 Pressing the **+/-** key, a stored input voltage parameter of the span is displayed in the unit of mV/V. Adjust the input voltage using **0** – **9** keys.

ENTER key. The key to store the span parameter and proceed to step 17.

ESC key The key not to change parameter and proceed to step 17.

5.2.10. Exiting the Calibration Mode

Step17 Check the **CALEnd** display.

Use the following keys.

CAL key Parameters are stored in the indicator and **CALoFF** is displayed.

Proceed to the next step.

CALoFF could be displayed by press and hold the **+/-** key and press the

ON/OFF key instead of **CAL** key.

ESC key The key to memorize parameters temporarily. Proceed to "CAL0" display.

Press and hold the **ESC** key and press the **ON/OFF** key

All parameters are not changed,

CAnCEL is displayed and the calibration mode is finished.

Step18 Press the **ON/OFF** key to turn the display off.



5.3. Weighing Range Function

The weighing range function can select "single range" and "dual range". Specify each weighing interval (division) for the multi-interval instrument. Each weighing interval is displayed according to a net value or gross value.

Caution □ Using a single range, it is not necessary to perform this function.

Example 1 The gross display.

Specified parameters:

First range Range = 50.00kg, division 0.02kg

Second range Range = 100.00kg (maximum capacity), division 0.1kg

Display

0kg to 50kg : The first range, division 0.02kg.

50kg to 100kg : The second range, division 0.1kg.

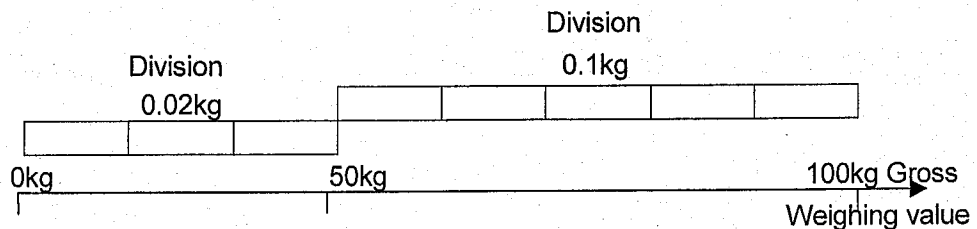

Example 2 The net display using a 40kg tare value.

Specified parameters:

The same parameters as example 1.

Display

-40kg to 50kg : The first range, division 0.02kg.

50kg to 60kg : The second range, division 0.1kg.

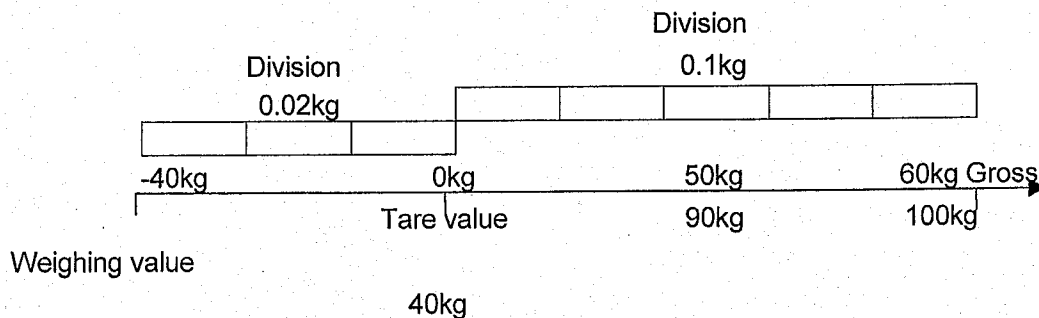

5.3.1. Setting Division and Range

Consider the following rules to design the weighing range.

- Rule 1 Select the division and range of each weighing range so as to fit the following inequality.
The first range < the second range
The division of next weighing range is automatically set bigger than division of lower weighing range. And the division can change.
- Rule 2 When setting the dual range, the upper limit value of the second range becomes the maximum capacity.
- Rule 3 Select a resolution smaller than 20000. The resolution is a value divided the maximum capacity by the minimum division of the first range.



5.4. Digital Linearization Function

Even if the zero and span calibration have been completed, there may still remain some linearity deviation by the performance of the weighing unit. The digital linearization function can rectify and reduce the linearity deviation using weighing points during the zero and capacity setting. Up to three weighing points can be specified.

- Caution**
- This function does not improve repeatability and hysteresis.
 - Use the mass on the condition that $Lnr\ 1 < Lnr\ 2 < Lnr\ 3$.
 - Do not press the **ENTER** key while the **STABLE** mark is off.

Middle point	Flash indication	▼ mark
First Point	Lnr 1	1
Second Point	Lnr 2	2
Third Point	Lnr 3	3

- Step 1 Press the **MODE** key to display **Lnr 0**.
- Step 2 Input zero point. Refer to "5.2.8. Zero calibration".
- Step 3 The value of the middle point is displayed after indicating **Lnr x**. x is 1, 2 or 3.
- Step 4 Select a way.
- Press the **ESC** key to finish this function. Proceed to step 7 and other points are cleared (canceled).
 - Select a middle point value using **0** - **9** keys. Proceed to step 5
- Step 5 Place a mass equivalent to the displaying value on the weighing unit. Press the **ENTER** key after the **STABLE** mark has turned on. Proceed to step 6.
- Step 6 If you add new middle point, proceed step 3, 4, 5.
If you finish this function, proceed to step 7.
- Step 7 Perform step 11 of "5.2.9 Span Calibration" immediately.



5.5. Gravity Compensation Function

- If the scale is used at the calibration location, it is not necessary to perform this function.
- It may cause a weighing error, if there is a difference of gravity acceleration between the installed location and calibration location. This function specifies these gravity accelerations and corrects span error.

Caution □ **The decimal point is not displayed in the function.** Ex. $\boxed{9798} = 9.798 \text{ m/s}^2$

Step 1 At $\boxed{\text{CAL } 0}$ display, press the $\boxed{\text{MODE}}$ key until $\boxed{\text{G SET}}$ is displayed and press $\boxed{\text{ENTER}}$ key to enter the gravity compensation function.

If you want to cancel the current procedure, press and hold the $\boxed{\text{ESC}}$ key and press the $\boxed{\text{ON/OFF}}$ key. Then, all parameters are not changed and the calibration mode is finished. Press the $\boxed{\text{ON/OFF}}$ key to turn the display off after displaying $\boxed{\text{CANCEL}}$.

Step 2 The parameter is displayed with triangle 1. Enter the gravity acceleration of the calibration location by $\boxed{0} - \boxed{9}$ keys. The parameter xxxx is the gravity acceleration. $\boxed{\text{ENTER}}$ key... The key to store the new gravity acceleration and proceed to step 3.

$\boxed{\text{ESC}}$ key The key not to change the value and go back to $\boxed{\text{G SET}}$.

Step 3 The parameter is displayed with triangle 2. Enter the gravity acceleration of the installed location by $\boxed{0} - \boxed{9}$ keys. The parameter xxxx is the gravity acceleration. $\boxed{\text{ENTER}}$ key.. The key to store the new gravity acceleration and proceed to step 4.

$\boxed{\text{ESC}}$ key The key not to change the value and go back to step 2.

Step 4 Now $\boxed{\text{G xxxx}}$ is displayed. Press the $\boxed{\text{CAL}}$ key to store the parameters. The $\boxed{\text{CALoFF}}$ is displayed. Proceed to step5.

Step 5 Press the $\boxed{\text{ON/OFF}}$ key to turn display off.

5.5.1. The Gravity Acceleration Table

Amsterdam	9.813 m/s ²	Manila	9.784 m/s ²
Athens	9.800 m/s ²	Melbourne	9.800 m/s ²
Auckland NZ	9.799 m/s ²	Mexico City	9.779 m/s ²
Bangkok	9.783 m/s ²	Milan	9.806 m/s ²
Birmingham	9.813 m/s ²	New York	9.802 m/s ²
Brussels	9.811 m/s ²	Oslo	9.819 m/s ²
Buenos Aires	9.797 m/s ²	Ottawa	9.806 m/s ²
Calcutta	9.788 m/s ²	Paris	9.809 m/s ²
Chicago	9.803 m/s ²	Rio de Janeiro	9.788 m/s ²
Copenhagen	9.815 m/s ²	Rome	9.803 m/s ²
Cyprus	9.797 m/s ²	San Francisco	9.800 m/s ²
Djakarta	9.781 m/s ²	Singapore	9.781 m/s ²
Frankfurt	9.810 m/s ²	Stockholm	9.818 m/s ²
Glasgow	9.816 m/s ²	Sydney	9.797 m/s ²
Havana	9.788 m/s ²	Tainan	9.788 m/s ²
Helsinki	9.819 m/s ²	Taipei	9.790 m/s ²
Kuwait	9.793 m/s ²	Tokyo	9.798 m/s ²
Lisbon	9.801 m/s ²	Vancouver, BC	9.809 m/s ²
London (Greenwich)	9.812 m/s ²	Washington DC	9.801 m/s ²
Los Angeles	9.796 m/s ²	Wellington NZ	9.803 m/s ²
Madrid	9.800 m/s ²	Zurich	9.807 m/s ²

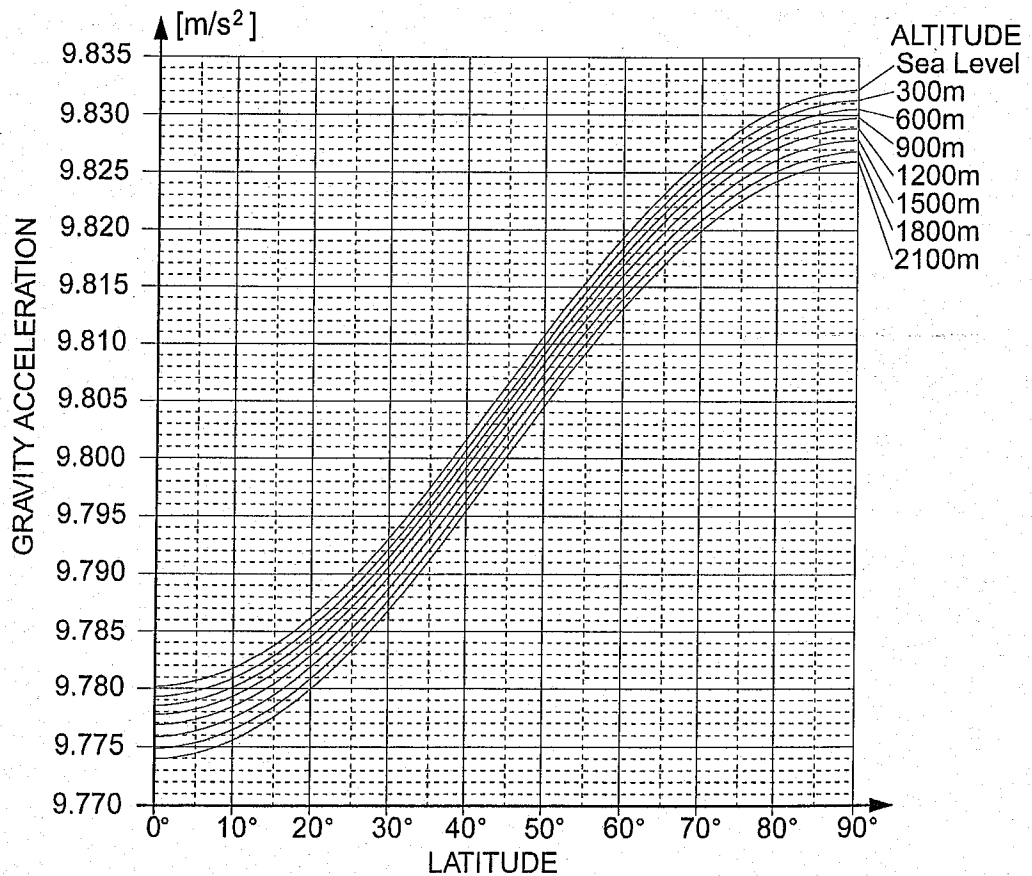



5.6. Calibration Error Code List

Exiting from the calibration error

ESC key The key to return the point occurred an error. Retry the operation.

Press and hold the **ESC** while pressing **ON/OFF** key.

All parameters are not changed, the **CAnCEL** is displayed and the calibration mode is finished. Press **ON/OFF** key to end this mode.

Error Code List

If an error has occurred during calibration mode, the following code is displayed.

Error code	Description
err 0	In multi-interval scale. The last division is set to maximum (d-50). Therefore the next division can not be entered.
err 1	Resolution exceeds 40000. (Resolution = maximum capacity/ minimum division) Reduce maximum capacity or increase minimum division.
err 2 err 3	Load cell output is too large or too small at zero calibration. Check the weighing unit and load cell. Refer to "3.1.4.Verifying Load Cell Output and Input Sensitivity".
err 4	Measuring calibration mass (or entering digital input), the value exceeded maximum capacity. Reduce calibration mass (or digital input).
err 5	Selected calibration mass is smaller than minimum division.
err 6	New input sensitivity is less than 0.2 μ V/division. Increase input sensitivity. Refer to "3.1.4.Verifying Load Cell Output and Input Sensitivity".
err 7	Placing mass on the weighing unit, the load cell output becomes a negative value. Check the load cell cable connections and the direction of load cell mounting.
err 8	Load cell output exceeds the input range before maximum capacity. Adjust zero balance referring to "3.1.4.Verifying Load Cell Output and Input Sensitivity". Replace with a load cell designed smaller output. Reduce maximum capacity.
err 9	The weighed value is out of the input range at zero calibration or span calibration. Check the weighing unit and cables.
err 12	The last weighing range is larger than next weighing range.
err 13	Incorrect mass is selected at the digital linearization function. Select mass of the following relation. Lnr 1 < Lnr 2 < Lnr 3.
g err	An unacceptable value was selected in the gravity acceleration function. Exit this error using the ON/OFF key.



6. Functions

There are two parameters list for the F-functions and CF-functions. These functions control the indicator. The parameters of each function are stored in the EEPROM, and are not lost even if power is turned off or cut off.

F-functions: These parameters can always be changed and are used for internal settings.

CF-functions: If you accept a certificated approval of the weighing instruments, the CAL cover must be sealed. Therefore, accepting this approval, these parameters of the CF-function can not be changed.



6.1. Changing the Function Settings

Enter function settings. To enter, do either of followings. When you are in the function setting F00 will be displayed .

1. when the unit is off, press **ON/OFF** key while pressing **NET/GROSS** key.
2. when it is in weighing mode, press both **NET/GROSS** and **ON/OFF** key at the same time.

Operating Item

Select an item using **0** – **9** keys.

ENTER key The key to display a parameter of the selected item.
Proceed to Operating parameter.

ESC key Ends function setting and enters weighing display.

CAL key The key to exchange F-functions and CF-functions.

Operating parameter

Select a parameter using **0** – **9** keys.

ENTER key The key to store a parameter and return Item number display.

ESC key The key not to change the parameter and return Item number display.

CLEAR key Change the display as default value.(Type1)
Change sub item.(Type2, Type3)
Type2 and Type3 are indicated in the parameter table.

Exit function setting

Press **ESC** key to go to the weight display when item number is displayed.



6.2. F-Functions

Weighing conditions (Digital Filter, Zero tracking and Stability)

Item	Parameter	Description
F00 Filter Motion / Averaging time	0	2 d/ 1.6s
	1	4 d/ 1.6s
	2	8 d/ 1.6s
	3	16 d/ 1.6s
	4	32 d/ 1.6s
	5	64 d/ 1.6s
	6	128 d/ 1.6s
	7	2 d/ 3.2s
	* 8	4 d/ 3.2s
	9	8 d/ 3.2s
	10	16 d/ 3.2s
	11	32 d/ 3.2s
	12	64 d/ 3.2s
	13	128 d/ 3.2s
F01 Zero tracking	0	OFF
	1	0.5 d/ 1s
	2	1.0 d/ 1s
	3	1.5 d/ 1s
	4	2.0 d/ 1s
	5	2.5 d/ 1s
	6	0.5 d/ 2s
	7	1.0 d/ 2s
	* 8	1.5 d/ 2s
	9	2.0 d/ 2s
	10	2.5 d/ 2s
F02 STABLE mark Motion detection condition	0	No motion detection
	1	0.5 d/ 0.5s
	2	1.0 d/ 0.5s
	3	2.0 d/ 0.5s
	4	3.0 d/ 0.5s
	5	4.0 d/ 0.5s
	6	0.5 d/ 1s
	7	1.0 d/ 1s
	* 8	2.0 d/ 1s
	9	3.0 d/ 1s
	10	4.0 d/ 1s
F03 Auto Printing/ Auto accumulation	0	1
	1	Twice in succession
	*2	Three times
	3	Four times

If weak filter is set, the response will be fast, but will be more sensitive to external influences such as vibration.

This function traces the weighing value drifting around zero point slowly, displayed as zero. If a strong parameter is set, a very small zero drift may be not detected.
If CF00 is 1, the 0, 1, 6 or 7 can be selected only.
If CF00 is 1, the initial setting sets 7.

The function to set the condition of judgment whether a weighing value is unstable or stable. The **ZERO** key and **TARE** key has effective in the stable state. If these keys need in the unstable state, set to F02 0. In case of CF00 1, F02 6 or F02 7 can be selected only. (Internal setting is 6.)

Set number of times when STABLE mark turned on in succession, until output/print out. CF00=1: could select only 2 and 3

d: division (weighing interval) of first range.

s: second.

*: Initial settings.

Display and other general functions

Item	Parameter	Description	
F04 Display update rate	* 0	5 times/s	The selection in the unstable condition.
	1	10 times/s	
F05 [Type2] Buzzer	1 x	Key click (ON/OFF)	Left: Item, select with ZERO key Right: On/Off, select 0 - 9 key 0: no sound, 1-4: beep
	2 x	LoLo /Zero band	
	3 x	Lo	
	4 x	OK	Initial value is 11, others x0
	5 x	HI	
	6 x	HiHi/Batch finish/Full	
F06 Device IDr(Address)	00 to 99	Command address or DeviceID	Initial setting is 00
	F07 Counting function	* 0	Disable
	1	Enable	

*: Initial settings. s: second.

Key switch

Item	Parameter	Description	
F12 [Type2] Disabling of key switch	10/11	CODE key	$10^2 = \text{Key}$ $10^1 = 0 \text{ Workable}$ 1 Disable ZERO key to select switch 0 1 key to select work/disable These options could be ignored when F13 – 15 is set to 17.
	20/21	SAMPLE key	
	30/31	SETPOINT key	
	40/41	PT key	
	50/51	TOTAL key	
	60/61	M+ key	
	70/71	START key	
	80/81	STOP key	
	90/91	FEED key	
	A0/A1	MODE key	
	B0/B1	ZERO key	
	C0/C1	TARE key	
	D0/D1	NET/GROSS key	
	E0/E1	PRINT key	

*: Initial settings.

External Input

Item	Parameter	Description		
F13 EXT1 Function selection of external input	*0	Not used (No function)		
	1	ZERO key		
	2	TARE key		
	3	NET/GROSS key		
	4	ON/OFF key		
	5	PRINT key, ENTER key		
	6	FEED key	Does not function for AD-4407	
	7	Serial data output(1)	Format 1	
	8	Serial data output(2)	Format 2	
	9	Accumulation		
	10	Batching start		
	11	Batching stop		
	12	"Over" signal	Gross weight over when ON	
	13	Gross display	Gross display when ON	
	14	Total display	Total display when ON	
	15	Start comparison	Processes comparison when ON	
	16	Switch units	Secondary unit when ON (when setting multiple units)	
	17	Validates all keys	Valid when ON (ignores F12 setting)	
	18	Prohibits reading of memory code	Does not read when ON (F13, 14, 15 =19)	
19	Memory code (BCD 1)			
F14 EXT2	0 - 18	Same as F-13		
	19	Memory code (BCD 2)		
F15 EXT3	0 -18	Same as F-13		
	19	Memory code (BCD 3)		

*: Initial settings.

Accumulation

Item	Parameter	Description	
F20 [Type2] Accumulation Mode	10/11	Do not add(0)/add(1)	
	20/21	Manual(0)/Automatic(1)	
	30/31	+ only(0) / both +/- (1)	
	40/41	Add only OK(0)/add all(1)	
F21 Inhibit region for accumulation	0	Add data anytime	
	* 1	Above ± 5 d	
	2	Above ± 10 d	
	3	Above ± 20 d	
	4	Above ± 50 d	
		Applicable for First Range only, when using Multi Interval Function.	

*: Initial settings.

Comparator

Item	Parameter	Description	
F22 Comparator function	* 0	Not used	
	1	Upper/lower limit comparison(2 Limits setting)	
	2	Upper/lower limit comparison(Target and allowance)	
	3	Upper/lower limit comparison(Target and % allowance)	
	4	HH/Hi/OK/Lo/LL comparison(4 Limits setting)	
	5	HH/Hi/OK/Lo/LL comparison(Target and allowance)	
	6	HH/Hi/OK/Lo/LL comparison(Target and % allowance)	
	7	Check weighing 1	
	8	Check weighing 2	
	9	Check weighing 3	
	10	Simple batch 1	
	11	Simple batch 2	
12	Simple batch 3(Loss in weight)		
F23 (F22=1-6) [Type2] Validation of comparison	10/11	Includes zero band(1)	Initial settings are 11,21,31,40
	20/21	Includes minus(1)	
	30/31	Stable(0) /All time(1)	
	40/41	All time(0)/Start, stop(1)	
F23 (F22=10-12) [Type2] Sub function for batch weighing	10/11	Tare when start(1)	Initial settings are 11,21,31,40
	20/21	Stop after Full by key(0)/Auto(1)	
	30/31	Over/Under judgment: after dribble flow(0)/Batch finish(1)	
	40/41	No function	
F24 Relay output selection	* 0	Over	Effective when F22=7,9,10,12
	1	Under	
	2	Finish/Full (F22=9,10,12)	
F25 Batch finish output time	00 to 99	Relay on time by 0.1second step (00:continuous to zero band)	Initial setting is 00
F26 Zero band	-999999 to 999999		Initial setting is 0

*: Initial settings.

Data output

Item	Parameter	Description	
F30 Data output	* 0	No data output	
	1	Analog output	Set F31, 32, 33
	2	Serial output	RS-232C, RS-422, RS-485
	3	(Reserve)	
	4	(Reserve)	

*: Initial settings.

Note When F30 setting is changed, press ON/OFF key to activate the data output properly

Analog output

Item	Parameter	Description
F31 Output data	* 0	Display data
	1	Gross data
	2	Net data
F32 Weight value at 4mA output	-999999 to 999999	Initial setting is 0
F33 Weight value at 20mA output	-999999 to 999999	Initial setting is 10000

*: Initial settings.

Serial data format

Item	Parameter	Description
F34 [Type3] Serial data format 1 Initial value 19,2E,3A,4F,50	x 0	Terminator
	x 1	ID number of unit(determined F06)
	x 2	Code number
	x 3	Data number
	x 4	Result of comparison
	x 5	(Reserve)
	x 6	(Reserve)
	x 7	Accumulated value
	x 8	Number of accumulation
	x 9	Stable/Over
F35 [Type3] Serial data format 2 Initial value 17,2F,30	x A	Displayed weight
	x B	Gross weight
	x C	Net weight
	x D	Tare weight
	x E	Weight type(G / N / T , cf. CF06)
	x F	Weight unit(cf. CF07)

ZERO key :
order of output
(1-999)
"Exxx" indicates the
end of setting order

NET/GROSS key:
Expand or shorten
output order

0 – 9 key
output data

Serial Interface

Item	Parameter	Description	
F40 Output mode	* 0	Stream mode	
	1	Manual mode, command is effective	
	2	Auto print mode(+), command is effective	
	3	Auto print mode(+/-), command is effective	
	4	When accumulation, automatically output	
	5	Command mode (output by command only)	
F41 Accumulated data output at accumulated data display	* 0	Manual, Fixed format	
	1	Auto, Fixed format	
	2	Manual, Format 1(F34)	
	3	Auto, Format 1(F34)	
	4	Manual, Format 2(F35)	
	5	Auto, Format 2(F35)	
F42 Delay for continual data	* 0	No delay	
	1	0.5 second	
	2	1.0 second	
	3	1.5 second	
	4	2.0 second	
F43 Command address	* 0	Not use	
	1	Use (Address determined F06)	
F44 Time out	* 0	Approx. 1 second	
	1	No limit	
F46 Decimal point/Delimiter	* 0	DP:point(,)/Deimitter:comma(,)	Common to sending/receiving
	1	DP:comma(,)/ Deimitter:semicolon(;)	
F47 Baud rate	0	600 bps	
	1	1200bps	
	* 2	2400bps	
	3	4800bps	
	4	9600bps	
F48 Data bit, parity	* 0	Data 7bit, Even parity	
	1	Data 7bit, Odd parity	
	2	Data 8bit, Non parity	

*: Initial settings. bps: bit per second.

Features unique to AD-4405
Calendar/clock function

Item	Parameter	Description	
F50 Time display	*0	12hrs. display (00-11 AM/PM)	
	1	24hrs. display (00-23)	
F51 Date format	*0	YY/MM/DD	
	1	MM/DD/YY	
	2	DD/MM/YY	
F52 Difference between Christian era	00 - 99	(Display/output year) - (Christian year)	Last 2 digits Initial setting is 0.
F53 Print/output of year	*0	2digits	
	1	4digits(Numeric)	First 2digits specified
	2	4digits(alphabets and year)	One alphabet and one space, or dot
F54 First 2ditigts of year	00 - 99	2digits number(F53=1) or alphabet, blank, dot	Effective F53=1 or 2

*: Initial settings.

Printer function

Item	Parameter	Description	
F60 Printing Mode (Form 1)	0	Do not print	
	*1	Key (Manual)	
	2	Auto print (+)	
	3	Auto print (+/-)	
	4	Print accumulated value 1	
	5	(Reserved)	no function
F61 Print accumulated display	0	Manual form(extended)1	
	*1	Auto form(extended)1	
	2	Manual form(extended)2	
	3	Auto form(extended)2	
F62 Repeat print	*0 0	0 (print x1)	Identical contents printed repeatedly
			10 ² : form 1
	9 9	9 (repeat print x 10)	10 ¹ : form 2
F63 Number of Paper Feed before Printing	*0 0	0 line	10 ² : form 1
			10 ¹ : form 2
	9 9	9 lines	
F64 Number of Paper Feed after Printing	*0 0	0 line	10 ² : form 1
			10 ¹ : form 2
	9 9	9 lines	
F65 Print direction	*0	Normal	
	1	Inverted	

*: Initial settings.

Print format

Item	Parameter	Description	
F70 [Type3] Print Format 1 Initial setting 1A0, 000	x 0	No print 0 0 : Line feed only	
	x 1	Device No. ID#	
	x 2	Code No. CD:x	
	x 3	Data No. No.xxxxx	
	x 4	HH/H /OK/L /LL	
	x 5	Date 11/11/11 YMD order decided F51	
	x 6	Time hh:mm:ss (AM or PM)	
	x 7	Accumulated value 07,17,27,57 only	
	x A	Display value G or N xxxx uu Effective only with 0A,4A	
	x B	Gross weight G xxxx uu Effective only with 0B,4B	
x C	Net weight N xxxx uu Effective only with 0C,4C		
x D	Tare Weight Effective only with 0D,4D		
F71 [Type3] Print format 2 Initial setting 180, 270, 000	0 x	No print	
	1 x	Device No. Not effective with 1A – 1D	
	2 x	Code No. Not effective with 2A – 2D	
	3 x	Data No. Not effective with 3A – 3D	
	4 x	Judged result: HH/H /OK/L /LL	
	5 x	Date Effective only with 50 to 54 and 56	
10 ² =Printing order 10 ¹ =Left side 10 ⁰ =Right side 000=Finish Printing	6 x	Time Effective only with 60 to 64	
	7 0	Accumulated value Total xxxx uu	
	8 0	Accumulation Number xxx	
	A 0	Display value G or N xxxx uu	
	B 0	Gross weight G xxxx uu	
	C 0	Net weight N xxxx uu	
	D 0	Tare Weight T xxxx uu	
	9 1	+	Print specified letters in one line.
	9 2	-	
	9 3	*	
	9 4	/	
	9 5	=	
	9 6	.	
	9 7	#	
9 A	Signature 'Signature' and line feed 3 lines.		



6.3. CF-Functions

Item	Parameter	Description																				
CF00 Zero track width, motion detection condition	* 0	No limitation																				
	1	Use limitation at F-01 02 and 03.																				
CF01 Zero range Turning display on, the range to zero display.	* 0	±2% of CAP, Tare limit is 100 % CAP																				
	1	±10% of CAP, Tare limit is 100 % CAP																				
	2	±3% of CAP, Tare limit is 50 % CAP																				
	3	±4% of CAP, Tare limit is 50 % CAP																				
CF02 Power on zero range Turning display on, the range to zero display.	* 0	Not to zero when turning display on.																				
	1	±10% of CAP																				
	2	± 3% of CAP																				
	3	± 4% of CAP																				
CF03 Zero tracking	0	Gross when displaying gross.																				
	1	Gross																				
	* 2	Gross or Net when displaying net.																				
CF04 TARE, ZERO in motion	* 0	Not accept TARE or ZERO in motion																				
	1	ExcuteTARE or ZERO even if in motion.																				
CF05 Output on over load and unstable state.	* 0	Not to output data at unstable value or over load. It is effective in key mode.																				
	1	To output data always.																				
CF06 Header 2	* 0	<table border="1"> <thead> <tr> <th></th> <th>Gross</th> <th>Net</th> <th>Tare</th> <th>Preset tare</th> </tr> </thead> <tbody> <tr> <td>* 0</td> <td>GS</td> <td>NT</td> <td>TR</td> <td>TR</td> </tr> <tr> <td>1</td> <td>GS</td> <td>NT</td> <td>TR</td> <td>PT</td> </tr> <tr> <td>2</td> <td>G~</td> <td>N~</td> <td>T~</td> <td>PT</td> </tr> </tbody> </table>		Gross	Net	Tare	Preset tare	* 0	GS	NT	TR	TR	1	GS	NT	TR	PT	2	G~	N~	T~	PT
			Gross	Net	Tare	Preset tare																
	* 0		GS	NT	TR	TR																
1	GS	NT	TR	PT																		
2	G~	N~	T~	PT																		
1																						
2																						
CF07 Figure number of unit	* 0	Two figurers																				
	1	Three figures																				
CF08 Accumulation function	* 0	Not used (Ineffective)																				
	1	Use (Effective)																				
CF09 Digital Tare(PT)	* 0	Use (Effective)																				
	1	Not used (Ineffective)																				

CAP : maximum capacity



7. Tare

- The function is used to display a net value with the container weight subtracted from the total weight, if you put an object into a container to weigh it.
- Using the serial interface (RS-232C etc.), you can perform from external equipment.

Caution

- **When turning the display off with CF02-1,2 or 3, the tare value is cleared.**
- **When turning the power off, the tare value is cleared.**

7.1.1. Weighing Tare

Operation Put the tare on the weighing unit. Press the **TARE** key to store the tare weight after the STABLE mark turns ON. The display changes to net.

Caution

- **When displaying a negative gross value, tare can not be used.**

7.1.2. Digital Input

Caution

- **The input value is rounded off to the unit of division(weighing interval).**
- **In case of CF02 1, 2 or 3(power-on zero), the display value will be zeroed when turning the display on.**
- **When using a multi-interval scale, usable input range is the first range.**
- **In case of CF09 1(To inhibit preset tare), preset tare can not be used.**
- **Preset tare is stored one of the Memory code data. Refer 9. Memory Code.**
- **Preset tare value can be set via serial interface.**

Step 1 Press the PT key to display the stored tare value.
When tare is cleared or is not used, the value is zero.

Step 2 Enter a new tare value using **0** - **9** keys.
ENTER key The key to store a new tare value.
The net is displayed.
ESC key The key not to change stored value and return to weighing display.

7.1.3. Clearing Tare

- When pressing the **TARE** key while gross is zero, tare is cleared and gross is displayed.
- When zeroing with the **ZERO** key, tare is cleared.



8. Accumulation

The function accumulates weighing data and stores sum of weight and count of weighing. Data is stored in the EEPROM, and is not lost even if the AC power supply is disconnected.

8.1.1. Preparation and Specification

Set the following parameters to use the accumulation function.

- Select CF08 1 for the CF-function so that the accumulation function becomes effective.
- Specify the method of accumulation and data at F20 of the F-function.
- Specify the inhibit range for accumulation at F21 of the F-function.

Selection of Accumulation Mode, F20 of the F-function

- There are two methods of manual accumulation, with the **M+** key operation and automatic accumulation.
- The accumulation data can select "positive data only" or "both polarity data".
- The accumulation data can select "result of comparison is OK only" or "all result".

Accumulation Condition, F21 of the F-function

- In case of manual accumulation mode, press the key to accumulate weighing data when the STABLE mark turned on.
- Data can be accumulated after weighing value becomes to the "inhibition region of output". When connecting power cord and truning display on, the accumulation mode makes the same action.

Inhibition region for accumulation	F21	Description
Add data anytime	F21 0	Stable data can be used anytime
Above ± 5 d	F21 1	Factory setting
Above ± 10 d	F21 2	
Above ± 20 d	F21 3	
Above ± 50 d	F21 4	

- Caution**
- Do not set to F21 0 for the automatic accumulation mode
 - If setting to F21 0, it may add the same data two times or more.

Limitation of Accumulation Count and Total

- The limitation of accumulation count is 999999.
 - The limitation of total is ± 999999 ignoring the decimal point.
 - If exceeding these limitations, data is not accumulated.
- Example: Setting the decimal point to second a figure like "0.0", the limitation is "99999.9".

8.1.2. Display and Operation

Action of Accumulating Data

- When accumulating data, the display blinks once.
If storing accumulation data, the M+ mark is displayed.

Caution □ **This function can not accumulate different unit data. Specify a unit before use.**

Display of Accumulation Data

- When setting to CF08 1 (Effective accumulation function) and pressing **TOTAL** key, then the **TOTAL** is displayed and the total data is displayed with the M+ mark blinking. A press of the **total** key again the display changes to the number of date added display. And when the **ESC** key is pressed, the weighing data is displayed.
- The total data can be output. Refer to "Output of Accumulation Data"

Undoing the Accumulation Data

- The last weighing data can be deduced from the accumulation data unless new data is accumulated.

Step 1 Press the **TOTAL** key to display **total** and accumulation data.

Step 2 Press and hold the **+/-** key more than 3 seconds. The display blinks once and the last accumulation data before accumulating last weighing data is displayed.

Caution □ **External input can not be used.**

Clearing the Accumulation Data

Step 1 Press **TOTAL** key to display **total** and accumulation data.

Step 2 Press and hold the **ZERO** key more than 3 seconds. The display blinks once and the accumulation data is cleared.

Caution □ **External input can not be used.**

Output of Accumulation Data

- Accumulation data can be output to the serial interface.
- Output by manual or automatic, and output data format is selectable F41 of F-functionsetting.

F41	Parameter	Manual/Automatic	Format
Accumulated data output at accumulated data display	* 0	Manual	Fixed format
	1	Automatic	
	2	Manual	Format 1(determine F34)
	3	Automatic	
	4	Manual	Format 2(determine F35)
	5	Automatic	

- Step 1 Press the key allocated to function the operation to display totAL and accumulation data.
- Step 2 If automatic output setting, data is output once at that timing.
- Step 3 If manual output, pressing the PRINT key while accumulated data displaying, the data is output.

Fixed data format :

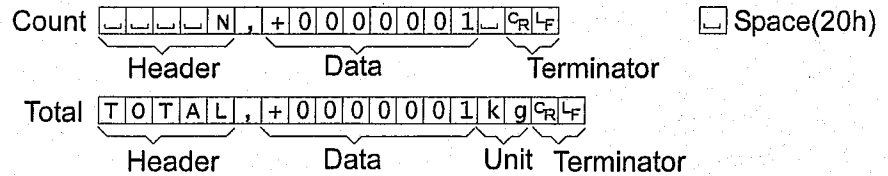

Print out of Accumulation Data (AD-4405 only)

- Accumulation data can be print out using the internal printer.
- Print out by manual or automatic, and output print format is selectable F61 of F-functionsetting.

F61	Parameter	Manual/Automatic	Format
Accumlated data print out at accumlated data display	0	Not print	
	1	Manual	Format 1(determine F70)
	2	Automatic	
	*3	Manual	Format 2(determine F71)
4	Automatic		

- Step 1 Press the key allocated to function the operation to display totAL and accumulation data.
- Step 2 If automatic print setting, data is printed out once at that timing.
- Step 3 If manual print, pressing the PRINT key while accumulated data displaying, the data is printed out.



9. Memory Code

- AD-4405/4407 has four memory codes(1 to 4). Each memory code memorize a set of setpoints and preset tare value.
- Data is stored in the EEPROM, and is not lost even if the AC power supply is disconnected or cut off.
- Memory code number 0 is temporary memory that the data is volatiled when AC power supply is disconnected or cut off.
- Active code memory number is changed by the key switch, external control input, or the command via serial interface.
- The memorized data set can copy one memory code to another memory code.

9.1.1. Using Memory Code

Step 1 Pressing **CODE** key at the weight display, the **Cd x** is displayed with present memory code number x blinks. Using following keys.

0 - 4 key The key to input code number.

CLEAR key The key to reset code number (0).

+/- key The key to copy the data set to another code number.

Proceed to step 3.

ESC key The key to go back to weight display.

ENTER key The key to determine code number, stop blinking. Proceed to step 2.

Step 2 Code number is determined and stop blinking. Using following keys.

SETPOINT key The key to setting comparison value. Refer "10.1.1. Setting Upper/Lower Limit Value".

PT key The key to setting preset tare value. Refer "7.1.2. Digital Input".

ESC key The key to go back to step 1.

ENTER key The key to set the selected code number's data and go back to weight display.

Step 3 **CoPY** is displayed for 2 seconds and then **C x- y** is displayed with y blinks. Using the following keys.

0 - 4 key The key to input code number to store.

ESC key The key to go back to step 1.

ENTER key The key to copy number x's data to number y and go back to step 1.



10. Comparison

- This function has the "upper / lower comparison", the "5-stage(HIHI/Hi/OK/LO/LOLO) comparison", the "setpoint comparison" and the "simple batch". They compare the weighing data with preset parameters and can output the result of the comparison to the display and beeping, also to the relay-outputs of OP-03 and OP-05.
- Set the F_i-function the F22 and F23 to use the "upper / lower comparison", the "5-stage(HIHI/Hi/OK/LO/LOLO) comparison" (these two comparison will be combined and be called "Weight check mode" from now), and F22 through F26 to use the "setpoint comparison" and the "simple batch".
- Data is stored in the EEPROM, and is not lost even if the AC power supply is disconnected or cut off.



10.1. Weight Check Mode

- This function compares the weighing data with the upper limit value and lower limit value(upper/lower limit comparison) or four limit values(HiHi, Hi, Lo and LoLo), and indicates, beep and/or outputs the result to the three relays of HI, OK and LO. Use this comparison when judging whether a weight is proper.
 - Set to the F-function F22 1, 2, 3 to use upper/ lower limit comparison and F22 4, 5, 6 to use 5-stage comparison.
 - Select a parameter of the F-function F23 for the comparison condition.
 - Specify the upper and lower limit / HiHi, Hi, Lo, LoLo limit values.
 - When inputting the lower limit value(s), it is not necessary to input the F-function F22 and F23 again unless changing the F-function.
 - 3 type of setting values for each comparison.
 - 1) Set limit value (upper limit and lower limit / HiHi, Hi, Lo, LoLo limit).
 - 2) Set Target value and acceptable tolerance(upper and lower) in weight.
Limit value is calculated automatically.
 - 3) Set Target value and acceptable tolerance(upper and lower) in percentage of the target weight. Limit value is calculated automatically.
- Example. Target = 50kg, Upper limit = 51kg, Lower limit = 48kg
- 1) Hi(Upper limit) : 51 (kg), Lo(Lower limit) : 48 (kg)
 - 2) TG(Target) : 50 (kg), Hi(Upper acceptable tolerance) : 1 (kg),
Lo(Lower acceptable tolerance) : 2 (kg) not minus value
 - 3) TG(Target) : 50 (kg), Hi(Upper acceptable tolerance) : 2 (% of Target),
Lo(Lower acceptable tolerance) : 4 (% of Target) not minus value

10.1.1. Condition formula for Comparison

Comparison is performed based on the following formula.

State Name	Condition Formula
HiHi *	HiHi limit value < Display value
HI	Upper limit (Hi limit) value < Display value
OK	Lower limit value \leq Display value \leq Upper limit value
LO	Display value < Lower limit (Lo limit) value
LoLo *	Display value < LoLo limit value

* HiHi and LoLo is 5-stage comparison only

- The decimal point is not considered. Example: If the upper limit value is 10.0, input 100.
- These parameters are stored in the EEPROM, and are not lost even if the AC power is disconnected or cut off.
- When the display value becomes an over load (positive over), HI/HiHi (over).
When the display value becomes an under load (negative over), output is Lo/LoLo (under).
- This function compares the HiHi limit value first.
- This function does not check the relation of upper limit value and lower limit value.

10.1.2. Setting Upper/Lower Limit Values

Step 1 Pressing **SETPOINT** key, the selected code memory number is displayed and the first comparison class term(ex.Hi, TG etc.) are blinking.

Step 2 Select comparison class using following keys.

SETPOINT key..... The key to select a comparison class.

ESC key The key to go back to the previous stage (weight display or code memory number input).

ENTER key The key to proceed to step 3.

Step 3 Set the setpoint value using the following keys.

0 - **9** key The key to input value.

ESC key The key not to change the value and proceed to the next comparison class (step 2).

ENTER key The key to store the value and proceed to the next comparison class (step 2).

10.1.3. Setting Order and Display for Weight Check Mode

F22	MODE	Display	1	2	3	4	5
1	Upper	Setpoint	Upper 1	Lower			
	Lower 1	Class	Hi	Lo			
		Comparator	HI	LO			
2	Upper	Setpoint	Target	Upper	Lower		
	Lower 2	Class	tG	Hi	Lo		
		Comparator	OK	HI	LO		
3	Upper	Setpoint	Target	Upper	Lower		
	Lower 3	Class	tG	Hi	Lo		
		Comparator	OK	HI	LO		
		Unit		%	%		
4	5-stage 1	Setpoint	HiHi	Hi	Lo	LoLo	
		Class	HH	Hi	Lo	LL	
		Comparator	HI	HI	LO	LO	
		Triangle	2			3	
5	5-stage 2	Setpoint	Target	HiHi	Hi	Lo	LoLo
		Class	TG	HH	Hi	Lo	LL
		Comparator	OK	HI	HI	LO	LO
		Triangle		2			3
6	5-stage 3	Setpoint	Target	HiHi	Hi	Lo	LoLo
		Class	TG	HH	Hi	Lo	LL
		Comparator	OK	HI	HI	LO	LO
		Unit		%	%	%	%
		Triangle		2			3



10.2. Setpoint Comparison

- This function includes the weighing sequence and uses for getting preset target weight.
- There are four parameters of "Final", "Preliminary", "Free fall" and "Zero band" to use the setpoint comparison.
- The result of the sequence is output to three relays.
- When inputting these parameters, it is not necessary to input the F-function F22 again unless changing the F-function.

10.2.1. Description of Input parameters and Outputs (F22 = 11)

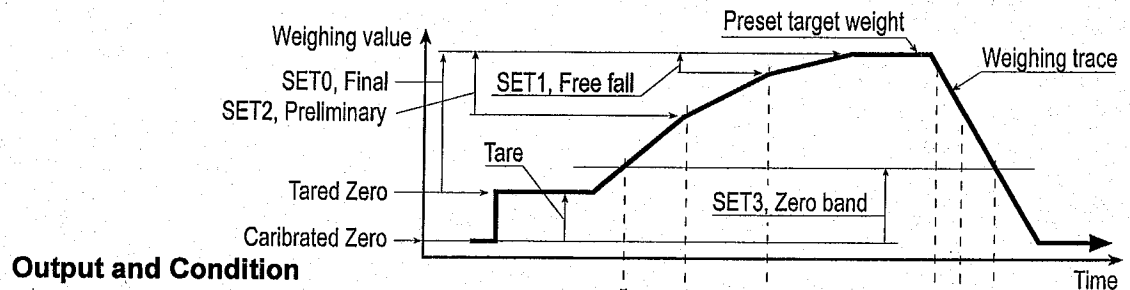

Output and Condition

Relay HI, $\text{Net} \geq (\text{Final} - \text{Free fall})$	OFF (Break)	ON (Make)	OFF (Break)
Relay OK, $\text{Net} \geq (\text{Final} - \text{Preliminary})$	OFF (Break)	ON (Make)	OFF (Break)
Relay LO, $\text{Gross} < \text{Zero band}$	ON (Make)	OFF (Break)	ON (Make)

Parameters List

SET0	Final	Set a preset target weight.
SET1	Free fall	Set a corrective value related to closing the dribble flow gate.
SET2	Preliminary	Set a beginning point to use the dribble flow gate only.
SET3	Zero band	Set a value to regard as nearly zero.

10.2.2. Setting the Parameters of Setpoint Comparison

See "9.1.2. Setting Upper/Lower Limit Values".

Zero band value is set at F26 of F-Function, and the value does not belongs specific code memory number but is used commonly.

10.2.3. Setting Order and Display for Setpoint Comparison and Simple batch

F22	MODE	Display	1	2	3	4	5
7	Setpoint Comparison 1	Setpoint	Final	Free fall	Over	Under	
		Class	Fi	FF	Hi	Lo	
		Comparator	OK		HI	LO	
		Triangle		1			
8	Setpoint Comparison 2	Setpoint	Final	Free fall	Preliminary	Over	Under
		Class	Fi	FF	Pr	Hi	Lo
		Comparator	OK			HI	LO
		Triangle		1	2		
9	Setpoint Comparison 3	Setpoint	Final	Free fall	Full	Over	Under
		Class	Fi	FF	Fu	Hi	Lo
		Comparator	OK			HI	LO
		Triangle		1	2		
10	Simple Batch 1	Setpoint	Final	Free fall	Over	Under	
		Class	Fi	FF	Hi	Lo	
		Comparator	OK		HI	LO	
		Triangle		1			
11	Simple Batch 2	Setpoint	Final	Free fall	Preliminary	Over	Under
		Class	Fi	FF	Pr	Hi	Lo
		Comparator	OK			HI	LO
		Triangle		1	2		
12	Simple Batch 3	Setpoint	Final	Free fall	Full	Over	Under
		Class	Fi	FF	Fu	Hi	Lo
		Comparator	OK			HI	LO
		Triangle		1	2		



11. Counting Function

This function is determine the number of objects in a sample based on the unit weight. Unit weight is stored one of the Memory Code data in the EEPROM, and is not lost even if the AC powr supply is disconnected.



11.1. Using Counting Function

- Preparation : Set F07 = 1 in the F-Function.
- Select Memory Code number. Refer to 9.1.1. Using Memory Code.
- Register the unit weigh. Refer to 11.2. Unit Weight Rgistration.
- Press **MODE** key to enter counting mode. The unit in the display changes **pcs**.
- In the counting mode TARE, ZERO, NET/GROSS and other operations are same as that in the normal weighing mode.



11.2. Unit Weight Registration

- There are two methods to register the unit weight. One is weigh the actual samples for unknown unit weight object and the another way is digital input the unit weight by key or via serial interface.
- Unit weight is one of the Memory Code data. Select Memory Code number and return to weight or counting display before register the unit weight. It cannot enter unit weight registration from Memory Code number display.

Weigh Actual Samples

When the unit weight is unknown, prepare some samples to determine the unit weight.

Step 1 Enter counting mode.

Step 2 Press **SAMPLE** key to enter the unit weight registration. **5 0** or **5 -** is displayed and unit **pcs** blinks. Left side is the number of samples. Right side of the display indicates weight, **0** means weight zero and **-** means not at zero.

Step 3 Select number of samples and place the number of samples specified on the weighing sensor unit. Using following keys.

0 - 9 key The key to set number of samples. Maximum is 9999.

+/- key The key to select number of samples, 5, 10, 20, 50, 100.

ZERO key The key to set zero point.

TARE key The key to tare. When using a container.

ENTER key The key to register unit weight and returns to piece count display. The unit weight is caluculated automatically with weight and number of samples.

Press **ESC** key while pressing **+/-** key The key to go back to piece count display without changing the unit weight.

- Notes**
- Large number of the samples is preferable to minimize the counting error.
 - Press **ENTER** key after Stable mark turns on.
 - If the total weight of samples is too light and is not adequate to be used as the unit weight, **LoUt** is displayed for 2 seconds and returns to registration display.

Digital input

When the unit weight is already known, digital input is available.

Step 1 Start with normal weight mode.

Step 2 Press **SAMPLE** key to enter the digital input of the unit weight. **U xxx** and the weight unit is displayed with unit **pcs** blinks. Using following keys.

0 - 9 key The key to set unit weight. Maximum is 5 digits.

+/- key The key to select the weight unit of the unit weight

ZERO key The key to clear the digital input. **U---** is displayed.

ESC key The key to not change the registered unit weight and go back to normal weight display.

ENTER key The key to register unit weight and returns to normal weight display.

Press **MODE** key while pressing **+/-** key The key to shift the decimal point.



12. RS-232C Interface



12.1. Specification

Transmission	Asynchronous, bi-directional, half-duplex
Baud rate	600, 1200, 2400, 4800, 9600 bps
Data bits	7 bits, 8 bits
Parity bits	1 bit, Even or Odd (for 7 data bits) or Non parity (for 8 data bits)
Start bit	1 bit
Stop bit	1 bit
Code	ASCII
Terminator	CR LF, CR (CR: 0Dh, LF: 0Ah)
Connector	D-sub 9 pin connector (AD-4405), Terminal block (AD-4407)

Circuit and Pin Connection

Pin No.		Signal name	Direction	Description
AD-4405	AD-4407			
2	1	TXD	Output	Transmit data
3	2	RXD	Input	Received data
5	4	SG	-	Signal ground
6	3	DSR	Output	Data set ready
7	no	RTS	-	Pin 7 is connected to pin 8 (AD-4405 only)
8	no	CTS	-	
Case	5	FG	-	Shield (Frame ground)
Other	no			Not used

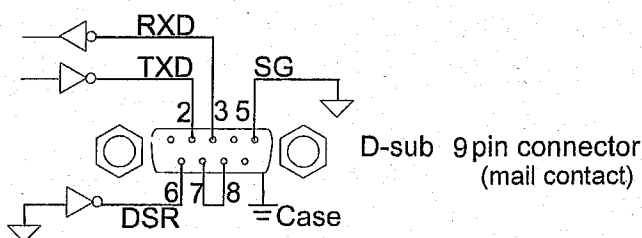

Bit Format

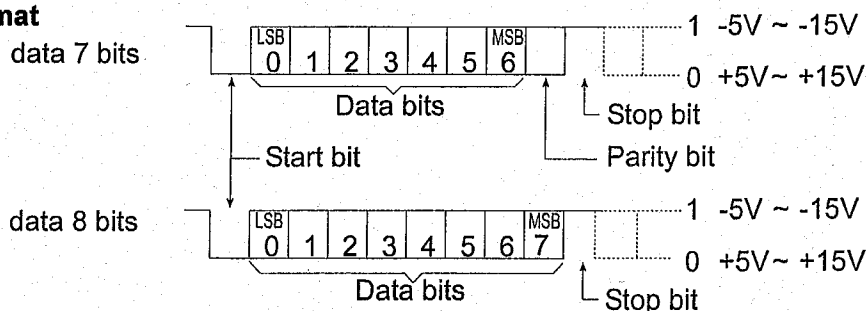



12.2. Data Output Mode

Description of "Stream Mode"

Object **F40 0**

Operation Data is output in every sampling (when refreshing the display).
Use this mode to output data to an external display (Data may not be output due to timing of the baud rate and internal sampling rate). If data is printed with pressing the **PRINT** key on the printer, use the stream mode.

Description of "Manual Print"

Object **F40 1**

Operation When pressing **PRINT** key at stable, weighing data is just output once.

Description of "Auto Print Mode"

Object **F40 2** or **F40 3**

Operation When weighing data varies from the "inhibition region of output" to the "permission region of output", the stable data is just output once. If you use this mode, set F02 except 0.

- When weighing each object and printing the data, use this mode.
- In case of **F40 2**
"Inhibition region of output" $\leq +5d$.
 $+5d < \text{"permission region of output"}$.
- In case of **F40 3**
 $-5d \leq \text{"inhibition region of output"} \leq +5d$.
 $\text{"Permission region of output"} < -5d, +5d < \text{"permission region of output"}$.
d: division (weighing interval) of first range.

Description of "Delay for continual data"

Object **F42**

Operation This function can be used in the "Auto print mode" and "Manual print mode".
After output the terminator, inserting interval time set at F42.
When using a non-buffered printer like the AD-8121, set to **F42 3**.



12.3. Data Format

- There are two type of data format freely set up at F-Function F34 and F35.
- The initial data format of F34 is shown below.

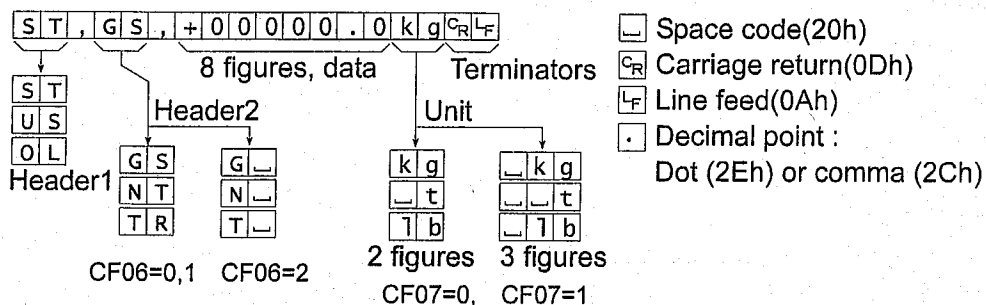

Header 1 F34,35 : 9(Status)

- ST St^ab^le weighing data.
- US Un^st^ab^le weighing data.
- OL Overload (Out of range).

Header 2 F34,35 : E(weight type)

- GS or G Gross data.
- NT or N Net data
- TR or T Tare data.

Data F34,35 : A, B, C, D (weight data)

The first of the data bits is the polarity whether "+" or "-".

When data is zero, the polarity is "+".

8 figures (bits) including polarity and decimal point(dot or comma).

In case of "out of range", the data bits are replaced by spaces except the decimal point.

Unit F34,35 : F (unit)

In case of CF07 0, the unit length is 2 figures.

In case of CF07 1, the unit length is 3 figures. Depending on circumstances, an A&D printer may not work correctly.



12.4. Command Format

Explanation of Command

- When performing a command, the received command or replay data is sent back.
- When the received command can not be performed such as the "busy" state, the code "I" is sent back. In this case, insert a delay time. Electrical noise may be the cause of this error.
- When receiving an undefined command (unknown command), the code "?" is sent back.

- Optional addresses can be appended to a command. The form of address is "@address" and this address is two figures specified at F-Function F06.

Example: Command is "Display net value". Address is 23.

Sending a command



Sending a command with address

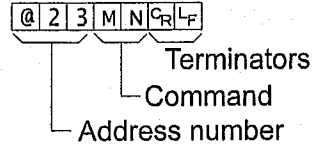

Unperformed command reply

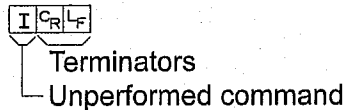

Unknown command reply

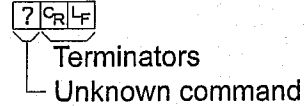

- Space code(20H)
- C_R Carriage return(0Dh)
- L_F Line feed(0Ah)

12.4.1. Command to Request Data

Request Display Data (1)

When receiving this command, Display data is sent back immediately.

Template RW

Command RWC_RL_F

Reply ST,GS,+00123.0kgC_RL_F

Request Display Data (2)

When receiving this command, data is sent back immediately with format 1 or 2.

Template RW,1 or RW,2

Command RW,1C_RL_F or RW,2C_RL_F

Reply Format1(F34) or Format2(F35)

Request Gross weight

When receiving this command, GROSS data is sent back immediately.

Template RG

Command RGC_RL_F

Reply ST,GS,+00123.0kgC_RL_F

Request Net weight

When receiving this command, NET data is sent back immediately.

Template RN

Command RNC_RL_F

Reply ST,NT,+00123.0kgC_RL_F

Request Tare weight

When receiving this command, TARE data is sent back immediately.

Template RT

Command

R	T	C _R	L _F
---	---	----------------	----------------

Reply

S	T	,	T	R	,	+	0	0	1	2	3	.	0	k	g	C _R	L _F
---	---	---	---	---	---	---	---	---	---	---	---	---	---	---	---	----------------	----------------

Request Accumulated Data (1)

When receiving this command, Accumulated data is sent back immediately.

Template RA

Command

R	A	C _R	L _F
---	---	----------------	----------------

Reply Refer Fixed data format of 8.1.2 Display and Operation, Output of Accumulation data

Request Accumulated Data (2)

When receiving this command, data is sent back immediately with format 1 or 2.

Template RA

Command

R	A	,	1	C _R	L _F
---	---	---	---	----------------	----------------

 or

R	A	,	2	C _R	L _F
---	---	---	---	----------------	----------------

Reply Format1(F34) or Format2(F35)

12.4.2. Commands to Control the Indicator

Zero Display

The current display is set to the zero point.

Template MZ

Command

M	Z	C _R	L _F
---	---	----------------	----------------

Reply

M	Z	C _R	L _F
---	---	----------------	----------------

Tare

The current display is set to zero of the net value.

Template MT

Command

M	T	C _R	L _F
---	---	----------------	----------------

Reply

M	T	C _R	L _F
---	---	----------------	----------------

Clear Tare Value

The tare value is cleared and the gross value is displayed.

Template CT

Command

C	T	C _R	L _F
---	---	----------------	----------------

Reply

C	T	C _R	L _F
---	---	----------------	----------------

Display Gross Value

The gross value is displayed.

Template MG

Command

M	G	C _R	L _F
---	---	----------------	----------------

Reply

M	G	C _R	L _F
---	---	----------------	----------------

Display Net Value

The net value is displayed.

Template MN

Command

M	N	C _R	L _F
---	---	----------------	----------------

Reply

M	N	C _R	L _F
---	---	----------------	----------------

Accumulation (M+)

Accumulate the displayed data.

Template MA

Command

M	A	C _R	L _F
---	---	----------------	----------------

Reply

M	A	C _R	L _F
---	---	----------------	----------------

Clearing the Accumulation data

Clear the accumulation data

Template CA

Command

C	A	C _R	L _F
---	---	----------------	----------------

Reply

C	A	C _R	L _F
---	---	----------------	----------------

Changing the weight Unit

Change the weight unit

Template UC

Command

U	C	C _R	L _F
---	---	----------------	----------------

Reply

U	C	C _R	L _F
---	---	----------------	----------------

Changing the Memory Code

Change the Memory Code

Template SC,m

m: memory code number, 1 - 4

Command

S	C	,	2	C _R	L _F
---	---	---	---	----------------	----------------

Reply

S	C	,	2	C _R	L _F
---	---	---	---	----------------	----------------

12.4.3. Commands to Set Parameters

Set Preset Tare

Set the preset tare value. The decimal point is not necessary because of according to display.

Template PT,m, [value]

m: memory code number, 1 - 4

Command

P	T	,	2	,	2	1	3	C _R	L _F
---	---	---	---	---	---	---	---	----------------	----------------

Reply

P	T	,	2	,	2	1	3	C _R	L _F
---	---	---	---	---	---	---	---	----------------	----------------

Set Unit Weight for Counting Mode

Set the unit weight value with decimal point.

Template UW,m, [value]

m: memory code number, 1 - 4

Command

U	W	,	2	,	2	1	.	3	C _R	L _F
---	---	---	---	---	---	---	---	---	----------------	----------------

Reply

U	W	,	2	,	2	1	.	3	C _R	L _F
---	---	---	---	---	---	---	---	---	----------------	----------------

Set Limit/Setpoint Value

Set the limit or setpoint value of the comparison. The decimal point is not necessary because of according to display.

Template Sm,n, [value]

m: memory code number, 1 - 4

n : setpoint order number, refer "Setting the setpoint"

Command

S	1	,	3	,	+	1	6	0	C _R	L _F
---	---	---	---	---	---	---	---	---	----------------	----------------

Reply

S	1	,	3	,	+	1	6	0	C _R	L _F
---	---	---	---	---	---	---	---	---	----------------	----------------

Set Zero band

Set the zero band value of the setpoint comparison. The decimal point is not necessary because of according to display.

Template SZ, [value]

Command

S	Z	,	+	7	4	8	C _R	L _F
---	---	---	---	---	---	---	----------------	----------------

Reply

S	Z	,	+	7	4	8	C _R	L _F
---	---	---	---	---	---	---	----------------	----------------

12.4.4. Commands to Set Data Output/ Print Format (UFC)

Set Serial data Format

Set the serial output data format.

Format 1 data is stored same memory area of F34 and format 2 data is stored same area of F35.

Template SF,f, [parameters]

f: Format number, 1 or 2

Command

S	F	,	1	,	\$	G	R	C _R	L _F
---	---	---	---	---	----	---	---	----------------	----------------

Reply

S	F	,	1	,	\$	G	R	C _R	L _F
---	---	---	---	---	----	---	---	----------------	----------------

Set Print Format (AD-4405)

Set the print data format.

Format 1 data is stored same memory area of F70 and format 2 data is stored same area of F71.

Template PF,f, [parameters]

f: Format number, 1 or 2

Command

P	F	,	1	,	\$	G	R	C _R	L _F
---	---	---	---	---	----	---	---	----------------	----------------

Reply

P	F	,	1	,	\$	G	R	C _R	L _F
---	---	---	---	---	----	---	---	----------------	----------------



12.5. UFC Command Parameter

UFC command such as SF1, PF1 has many parameters.

- One commandline can has plural number of parameters. Parametrs are stored in the memory in order.
- Plural UFC command is acceptable. The parameters are stored next to the last parameter stored by the last UFC command.
- There are several types of the parameter description.

data Weight, result of comparison etc.

\$CL Clear previous settings. UFC command cannot change partially.

\$WT Display data

\$GR Gross data

\$NT Net data

\$TR Tare data

\$HD Gross/Net/Tare or Preset tare. Refer CF06.

\$UT Weight unit

\$ST Stable/Unstable

\$CP Result of comparison

\$ID Specified F06

\$DT Date(AD-4405)

\$TM Time(AD-4405)

\$DN Data number increment every output automatically

\$CD Memory code number

\$AN Number of accumulation

\$TL Total weight

\$CM Comma

\$CR CR code(0Ah)

\$LF LF code(0Dh)

\$DE Delete the last parameter

\$DL Inserting delay time(0.1 second step) ex. DL10 : 1.0second delay

strings Output or print specified strings. ex. 'A & D'
' itself describes ""

hexdecimal Contol code of the printer etc. ex. #09

2 characters followed by # is hex-decimal code.

- Exmple

SF1,\$ID\$DN\$CR\$LF\$GR\$UT\$CR\$LF

SF2,' Welcome to A & D'\$LF'Total weight '\$AN\$TL\$LF\$LF



13. Calendar / Clock (AD-4405 only)

AD-4405 has a built-in calendar/clock backed up by a lithium battery. The calendar/clock continues to operate with AC power turned off. Leap years are automatically corrected. The time and date can be added to the data output and optional built-in printer output.



13.1. Time and Date Functions

Item	Parameter	Description	
F50 Time display	*0	12hrs. display (01-12 AM/PM)	display, data output and print output
	1	24hrs. display (00-23)	
F51 Date format	*0	YY/MM/DD	display, data output and print output
	1	MM/DD/YY	
	2	DD/MM/YY	
F52 Difference between Christian era	00 - 99	(Display/output year) – (Christian year)	Last 2 digits Initial setting is 0.
F53 Print/output of year	*0	2digits	First 2digits specified, year setting not interlocked.
	1	4digits(Numeric)	
	2	4digits(alphabets and year)	
F54 First 2ditigts of year F53=2,3	00 - 99	2digits number(F53=1) or alphabet, blank, dot	

F52 : The display or output year is calculated next formula.

Display/output year = (Christian era) + (F52)

Example1: Christian era = (20)03, F52 = 10 then display/output year = (20)13

Example2: Christian era = (20)03, F52 = 99 then display/output year = (20)02

Keep internal year in Christian era because of the leap year correction.

F53 and F54 : It can be added 2 digit characters before internal year to the output of the year (but can not display 4 digit year). Additional characters are set by F54.

F53=0 No character to add, output year is 2characters

F53=1 Add 2 digit numeric characters. These 2 digits does not increment automatically if internal year changes 99 to 00.

Example: Setting F54 = 20, internal year(after F52 calculate) = 03,
output year = 2003

F53=2 Add 2 digit alphabet characters including space and dot. There are 3 types, an alphabet and a space, an alphabet and a dot, and one space and an alphabet. Setting is specify 2 digit numbers from the next table. If F54 setting number is not in the table, two spaces is output.

Output characters and F54 setting (F53=2) (_ : space)

Out	F54	Out	F54	Out	F54	Out	F54	Out	F54	Out	F54
A	01	N	14	A.	31	N.	44	A	61	N	74
B	02	O	15	B.	32	O.	45	B	62	O	75
C	03	P	16	C.	33	P.	46	C	63	P	76
D	04	Q	17	D.	34	Q.	47	D	64	Q	77
E	05	R	18	E.	35	R.	48	E	65	R	78
F	06	S	19	F.	36	S.	49	F	66	S	79
G	07	T	20	G.	37	T.	50	G	67	T	80
H	08	U	21	H.	38	U.	51	H	68	U	81
I	09	V	22	I.	39	V.	52	I	69	V	82
J	10	W	23	J.	40	W.	53	J	70	W	83
K	11	X	24	K.	41	X.	54	K	71	X	84
L	12	Y	25	L.	42	Y.	55	L	72	Y	85
M	13	Z	26	M.	43	Z.	56	M	73	Z	86

Example: Setting F54 = 38, internal year(after F52 calculate) = 15,
output year = H.15



13.2. Setting Time and Date

Step 1 Pressing **PT(4)** key while press and hold **PRINT** key, **timE** will display.
Use following keys.

MODE key The key to select time(timE) or date(dAtE) to set.

ESC key The key to go back to weight display.

ENTER key The key to proceed to step 2(time) or step 3(date).

Step 2 Present time is displayed with F50 setting and is updating. Triangle indicates AM(lit 2)/PM(lit 3) and no triangle lit in 24 hour setting. Set time using following keys. Once enter effective key, it stops to update the time.

0 - 9 key The key to set value at blinking figure, after that the blinking figure shift to the right. (Illegal numbers are ignored.)

+/- key The key to shift the blinling figure to the right (including triangle).

CLEAR key The key to reset settings and display present time.

MODE key The key to change AM and PM when triangle 2 or 3 is blinking.

ESC key The key to not to change time setting and go back to **timE** display.

ENTER key The key to store the time and go back to **timE** display.

Step 3 After displaying date format for 2 seconds, present date is displayed in F51 format. F52 setting is effective in the setting mode. Set date using the following keys.

0 - 9 key..... The key to set value at blinking figure, after that the blinking figure shift to the right. (Illegal numbers are ignored.)

+/- key The key to shift the blinling figure to the right.

CLEAR key The key to reset settings and display present date.

ESC key The key to not to change date setting and go back to **dAtE** display.

ENTER key The key to store the date and go back to **dAtE** display.

If it has some illegal numbers, storing with correction below.

Correction: Over day to the 1st day of the next month

Example: Month 4, 6, 9, 11 and day 31

Month 2 and day bigger than 28 or 29(leap year)

Leap year is the multiple of 4 of Christian era (00, 04, ..., 96)



14. Specifications

Analog Input and A/D Conversion

Input sensitivity	Up to 0.2 μ V/division
Input signal range	-1 mV ~ 15 mV
Load cell excitation voltage	5V DC \pm 5%, 60 mA with sense voltage input (AD-4405) 5V DC \pm 5%, 120 mA with sense voltage input (AD-4407)
Load cell drive capacity	Maximum 4 x 350 Ω load cells (AD-4405) Maximum 8 x 350 Ω load cells (AD-4407)
Temperature coefficient	
Zero	\pm (0.2 μ V + 0.0008 % of zero adjustment voltage)/ $^{\circ}$ C (typ.)
Span	\pm 0.0008%/ $^{\circ}$ C of reading (typ.)
Non-Linearity	0.01 % of full scale
Maximum input noise	Less than 0.4 μ Vp-p
Input impedace	10 M Ω or more
A/D conversion method	Integrating dual slope type
A/D resolution count	40000 counts
A/D conversion rate and display update rate	Approximately 10 times/s
Maximum display resolution	20000 (permissible 40000)

Digital Section

Measurement display	7 segment, Vacuum fluorescent display tube
Character color	Cobalt-blue
Character height	20 mm
State indicator Symbol	Minus sign, Zero point, Stable, Net, Preset tare value, Storing accumulation data, Percentage, Various state indicator(triangle1,2,3)
Character color	Cobalt-blue
Comparison result	HI, OK, LO
Character color	Red for HI and LO, Green for OK
Unit	kg, t, lb
Character color	Cobalt-blue

Interface

RS-232C interface	Serial interface for communication D-Sub 9P for AD-4405, Terminal block for AD-4407
RS-422/485 interface	Serial interface for communication, control (terminal block)
Analog output	4-20mA, free scaling output (terminal block)
External Control Input	3 contact input terminals selected functions
Relay output	3 point Capacity: 50V AC/DC, maximum current 100mA (resistive load) Comparison mode selection HIHI, HI, OK, LO, LOLO output for limit comparison Zero band, preliminary, free fall, final for setpoint comparison

Printer (AD-4405 only)

Built-in printer	5 x 7 dot matrix type, 16 digits per line
------------------	---

General

Power supply	Selection by internal connector from 100V AC, 120V AC, 200V AC and 230V AC, +10% to -15%, 45Hz to 65Hz
Power consumption	Approximately 20VA
Operation temperature	-10°C to +40°C (14°F to 104°F)
Operation humidity	85% R.H. (no condensation)
Mass	1300g approximately (AD-4405) 1950g approximately (AD-4407)
Dimensions	275(W) x 111(H) x 159(D) mm (AD-4405) 199(W) x 206(H) x 80(D) mm (AD-4407)
Accessories	Refer to "4.1.4.Accessories and Option"



14.1. Dimensions

AD-4405

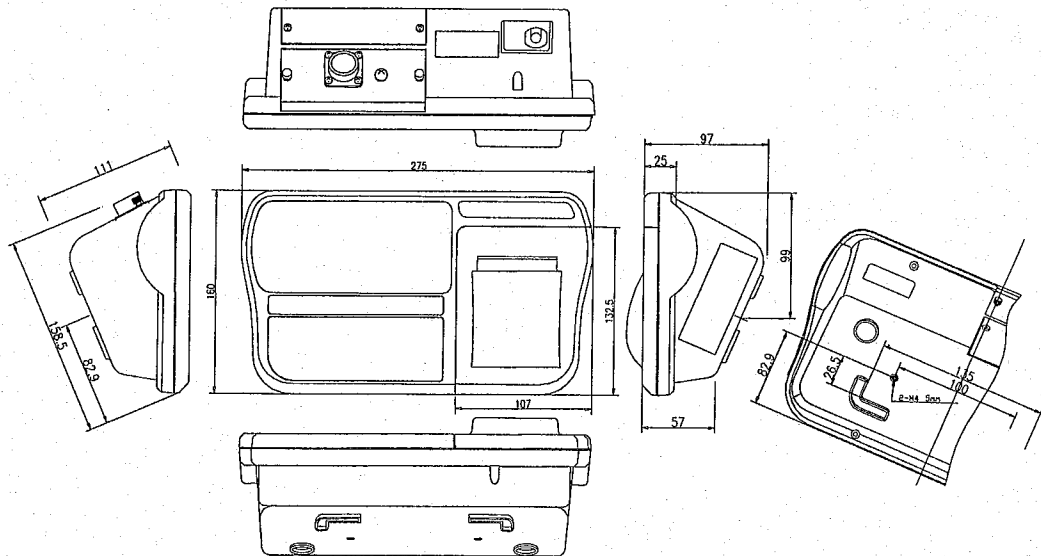

AD-4407

