

Guide for installers

METTLER TOLEDO MultiRange System solution Point Ex

METTLER TOLEDO

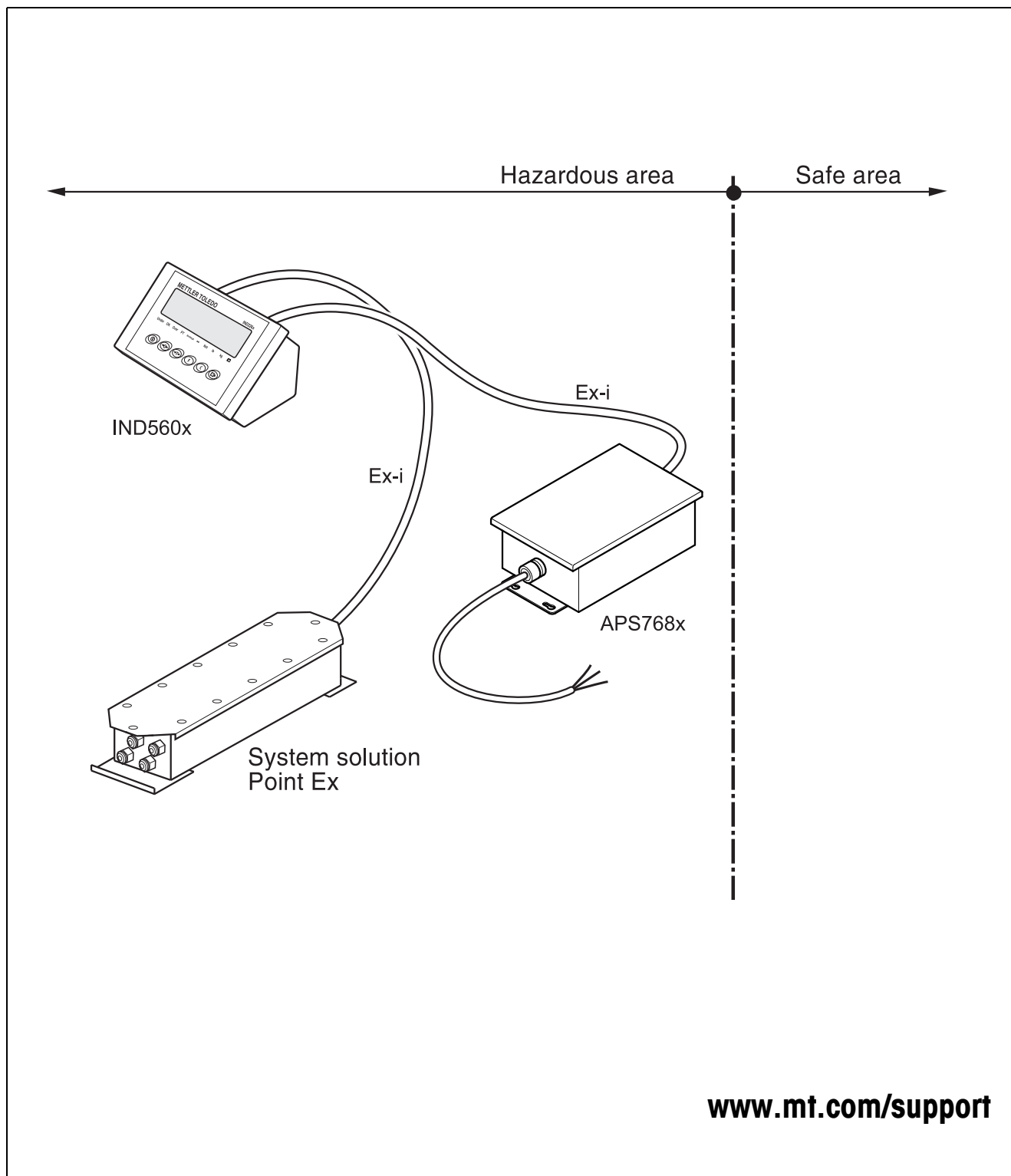

Contents		Page
1	Safety precautions	4
2	System overview	5
2.1	Using the System solution Point Ex	5
2.2	Typical configurations	5
2.3	Description of the components	6
3	Installation.....	7
3.1	Setting up System solution Point Ex	7
3.2	Equipotential bonding	9
3.3	Connecting power supply	9
3.4	Configuration	9
3.5	Corner adjustment	9
4	Making connection cables.....	11
5	Technical data	12
5.1	General technical data.....	12
5.2	Intrinsically safe characteristic values of the Point Ex A/D converter	13
5.3	Dimensional drawing	13
6	Accessories.....	14
7	Disposal	15

1 Safety precautions



The System solution Point Ex is approved for operation in Zone 1 and 21 hazardous areas.

Particular care is required when using weighing systems with the System solution Point Ex in hazardous areas. The code of practice is oriented to the "Safe Distribution" concept drawn up by METTLER TOLEDO.

- Competence** ▲ The System solution Point Ex may only be installed, maintained and repaired by authorised METTLER TOLEDO service personnel.
- Ex approval** ▲ No modifications may be made to the terminal and no repair work may be performed on the modules. Any weighing cells or system modules that are used must comply with the specifications contained in the installation instructions. Non-compliant equipment jeopardises the intrinsic safety of the system, cancels the "Ex" approval and renders any warranty or product liability claims null and void.
- ▲ The safety of the weighing system is only guaranteed when the weighing system is operated, installed and maintained in accordance with the respective instructions.
- ▲ Also comply with the following:
- the instructions for the system modules and weighing cells
 - the regulations and standards in the respective country
 - the statutory requirement for electrical equipment installed in hazardous areas in the respective country
 - all instructions related to safety issued by the owner
- ▲ The explosion-protected weighing system must be checked to ensure compliance with the requirements for safety before being put into service for the first time, following any service work and every 3 years, at least.
- Operation** ▲ Prevent the build-up of static electricity. Always wear suitable working clothes when operating or performing service work in an hazardous area.
- ▲ Do not use protective coverings for the devices.
- ▲ Avoid damage to the system components.
- Installation** ▲ Only install or perform maintenance work on the weighing system in the hazardous areas if the following conditions are fulfilled:
- the intrinsically safe characteristic values and zone approval of the individual components are in accord with one another
 - the owner has issued a permit ("spark permit" or "fire permit")
 - the area has been rendered safe and the owner's safety co-ordinator has confirmed that there is no danger
 - the necessary tools and any required protective clothing are provided (danger of the build-up of static electricity)
- ▲ The certification papers (certificates, manufacturer's declarations) must be present.
- ▲ Lay cabling securely so that it does not move and effectively protect it against damage.
- ▲ Only route cables into the housing of the system modules via the suitable cable gland and ensure proper seating of the seals.

2 System overview

2.1 Using the System solution Point Ex

The System solution Point Ex is used for connecting intrinsically safe weighing cells or weighing platforms with intrinsically safe weighing cells.

Tasks of the System solution Point Ex

- Conversion of analogue signals into digital signals
- Power supply for analogue weighing cells

Application examples

- Expansion of DMS weighing platform conversion kits with analogue/digital electronics
- Construction of special scales, e.g. container scales, consisting of several DMS weighing cells and a container placed on top

2.2 Typical configurations

2.2.1 System solution Point Ex, weighing terminal IND560x, APS768x and DMS weighing cells

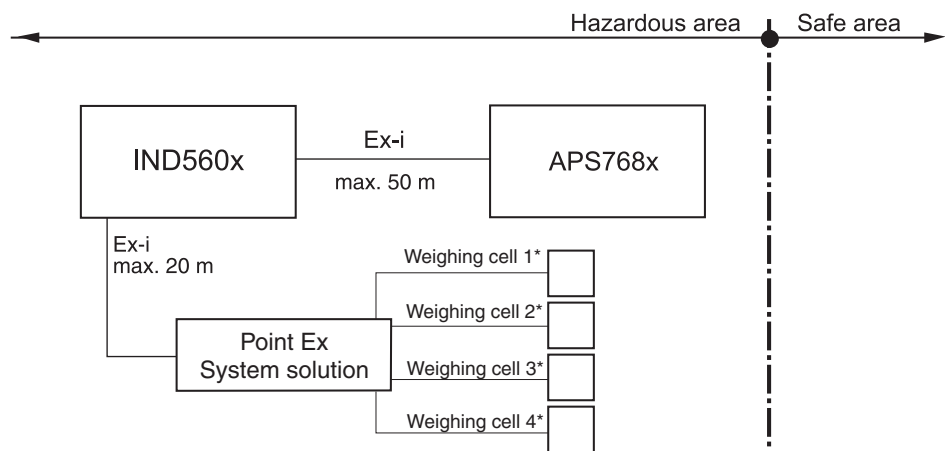

* Minimum supply impedance of 87Ω

The weighing cells must be approved for the hazardous area. The intrinsically safe characteristic values must be in agreement with those of the Point Ex system solution.

2.2.2 System solution Point Ex, ID... weighing terminal and DMS weighing cells

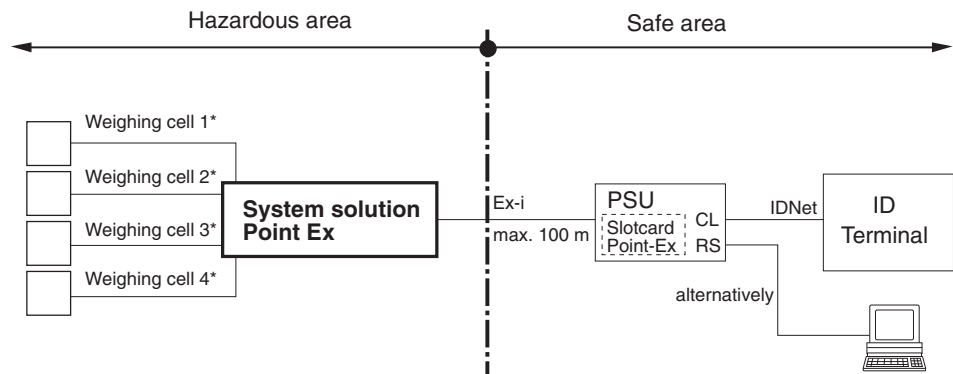

* Weighing cells must be approved for the hazardous area. The intrinsically safe characteristic values must be in agreement with those of the Point Ex system solution.

2.3 Description of the components

System solution Point Ex	Ignition protection type	EN	II 2G Ex ia IIC T4 Gb
			II 2D Ex tc IIIC IP67 T75°C Db
	Ignition protection type	FM	IS Class I, II, III; Division 1
			Group A, B, C, D, E, F, G / T4
	Temperature range		-20 °C to +60 °C
	Protection type		IP68
	Connection cable		5 m

APS768x / PSU power supply unit See APS768x / PSU guide for installers.

IND560x weighing terminal See IND560x installation manual.

Weighing cells See prototype test certificate of weighing cells.

3 Installation

3.1 Setting up System solution Point Ex

3.1.1 Preparing System solution Point Ex



EXPLOSION HAZARD

Explosion hazard because not sufficiently dustproof!

- If the System solution Point Ex power supply unit is used in dust explosion hazard areas ensure that the degree of protection IP6x is ensured. In this respect ensure the correct position of the seals and the maximum tightening torque of the screwed connection.
- During every maintenance interval check the respective tightening torque and tighten if necessary.

Screw	M4 x 0.7	M12 x 1.5	M16 x 1.5
Max. tightening torque	1.2 Nm	4.0 Nm	2.0 Nm

1. Open cover of the System solution Point Ex by loosening the 12 screws.
2. Ensure that Point Ex mode is set. The respective mode must be identified on the PCB.

3.1.2 Connecting DMS weighing cells

Preparing cell cable

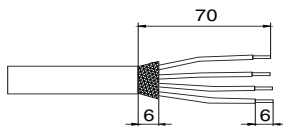

1. Strip cable end approx. 70 mm.
2. Shorten cable shield to 6 mm.
3. Strip the wire ends approx. 6 mm and twist them.
4. Push on the wire end ferrules and press them on firmly with a pair of crimping pliers.

Attaching cable gland to cell cable

Note

Measures for shielding against incoming and outgoing interference are especially important with longer cell cables. The maximum interference immunity classes will only be achieved with careful and proper installation and wiring of all connected peripherals and weighing platforms.

For this purpose, it is extremely important to connect the shielding on both sides in a professional manner.

The CE-conformity of the entire system is the responsibility of the person commissioning the device.

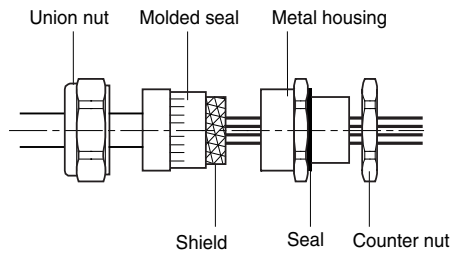

1. Slide the union nut and moulded seal over the prepared cable.
2. Place cable shield over the contact.
3. Screw in metal housing with union nut.

Connecting cell cable to the System solution Point Ex

1. Screw cable to the housing. Ensure proper seating of seal when doing so!
2. Identify weighing cells (1 to 4).
3. Connect weighing cell cables in accordance with the drawing on the System solution Point Ex.
For 6-conductor weighing cells with a Sense connection, lead the Sense connections from each of two weighing cells to one terminal if necessary.

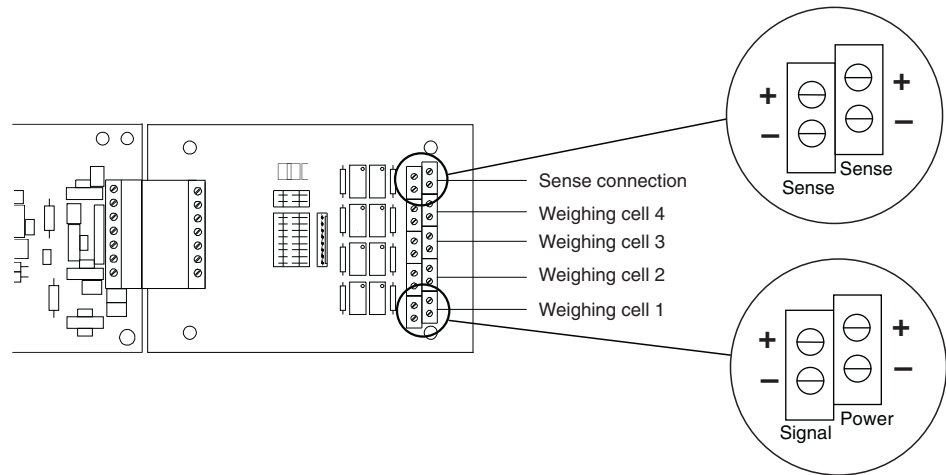

Connecting System solution Point Ex to PSU

See control drawings 22006477 in the PSU guide for installers (ME-22006472).

Connecting System solution Point Ex to IND560x and APS768x

See control drawing 22006397 in the APS768x guide for installers (ME-22021223).

3.2 Equipotential bonding

Equipotential bonding must be installed by an electrician authorised by the owner. METTLER TOLEDO Service only has a monitoring and consulting function here.

- Connect equipotential bonding (PA) of all devices (power supply unit, weighing terminal and weighing platform) in accordance with the terminal diagram and the country-specific regulations and standards. In the process it must be ensured that
 - all device housings are connected to the same potential via the PA terminals
 - no circulating current flows via the cable shielding for intrinsically safe circuits
 - the neutral point for equipotential bonding is as close to the weighing system as possible

3.3 Connecting power supply

See APS768x guide for installers.

3.4 Configuration

The configuration of the System solution Point Ex is described in the service manual for the Point A/D converter.

3.5 Corner adjustment

Corner compensation must be performed after configuration and calibration of the weighing system.

3.5.1 Checking the cornerload

Checking of a multi-sensor weighing platform with four weighing cells is described in the following.

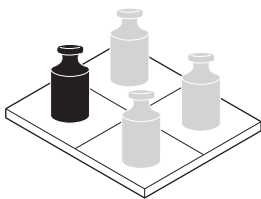

1. Place the test weight (1/3 of maximum load) in the center of the load plate and tare.
2. Load test weights in succession in the middle of each of the four quadrants, and note absolute value with sign.

Adjustment is required for deviations greater than the permissible verification error limit.

3.5.2 Adjusting corners

Notes

- Begin the adjustment at the corner with the greatest deviation.
- The adjustment of weighing cell 1 occurs at the potentiometer pair 1, cell 2 at pair 2, etc.

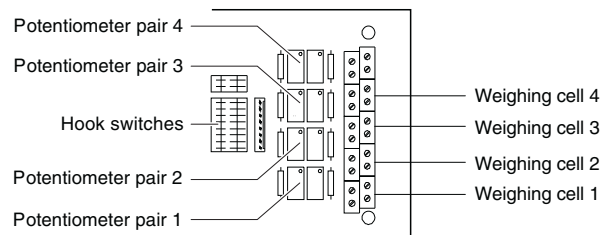

1. Switch off weighing system.
2. Open all hook switches.
3. Move all potentiometers to the middle position.
4. With a **positive** deviation: Turn both potentiometers the same number of rotations to the **right**.
With a **negative** deviation: Turn both potentiometers the same number of rotations to the **left**.
5. After completing corner adjustment, screw the cover of the system solution back on. Ensure proper seating of seal when doing so.

4 Making connection cables



EXPLOSION HAZARD

- Take the parameters of the cable used into consideration when checking the intrinsically safe parameters.
- Use only cables approved for use in the hazardous area.



EXPLOSION HAZARD

Explosion hazard because not sufficiently dustproof!

- If the System solution Point Ex power supply unit is used in dust explosion hazard areas ensure that the degree of protection IP6x is ensured.

Customer-specific weighing platform cables for intrinsically safe circuits must be fabricated as follows:

	Cable	Dim. A (system solution)	Dim. B (IND560x/PSU)	Max. length
System solution Point Ex – IND560x	3 x 2 x 0.75 mm ²	80 mm	215 mm	20 m
System solution Point Ex – PSU	3 x 2 x 0.75 mm ²	80 mm	215 mm	100 m

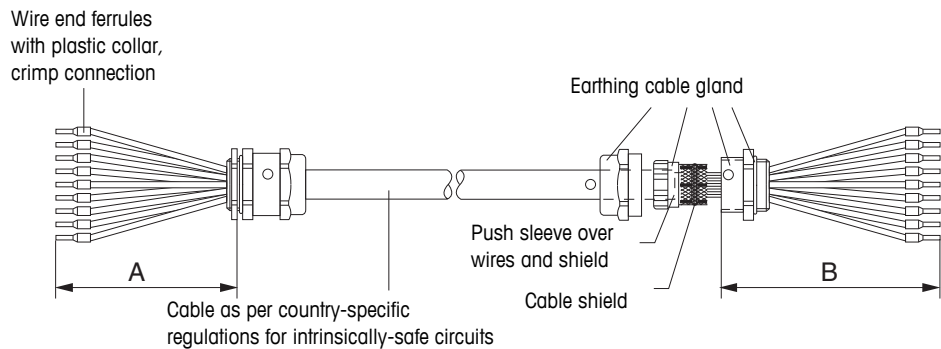

1. Cut cable to length and strip cable ends according to dimension A/B.
2. Shorten shield on both sides to 10 mm.
3. Strip wire ends.
4. Crimp wire end ferrules onto wire ends with a crimping tool.
5. Push second rear section of earthing cable gland onto cable.
6. Push sleeve over wires and shield. Fold over cable shield.
7. Push on front section of cable gland and screw onto rear section.

5 Technical data

5.1 General technical data

Metrological data	
Input signal range	0 to 3 mV/V
Supply voltage	6 V
Weighing platform impedance	87.5 to 1100 Ω in conjunction with PSUx and supply through U6 87.5 to 1100 Ω in conjunction with PSU/..-Ex and the Point-Ex slotcard 250 to 1100 Ω in conjunction with PSU/..-Ex and the TBrick-Ex slotcard
Smallest perm. verif. incr.	0.40 μV/e
Fraction of the error limit (P _i)	0.5
Number of weighing cells	max. 4
Number of verifiable increment values	max. ≤ 7500 e
Scales configuration	Single range (SR) Multi-range (MR), max. three areas Multi-interval (MI), max. three intervals
Temperature range	Verification class III -10 °C to +40 °C
Housing	
Housing protection type	Metric terminal box IP68
Housing type	Chrome-nickel-steel (1.4301)
Operating modes	Point Ex mode Connection of U1 (5) and U2 (10) Optional mode Connection of U1 (5) The mode is set at the factory and is identified on the PCB.
Weight (incl. cables)	net 1.7 kg
Application location	to be used only in interiors
Ex-i connection cable	From the factory 5 m long cable enclosed, on both sides cable gland M16x1.5 pre-assembled. If required longer cable possible, see chapter 4.
Dimensions L x W x H	350 x 84 x 44 mm (without connection parts)
Relative humidity	20 % – 80 %, non-condensing

5.2 Intrinsically safe characteristic values of the Point Ex A/D converter

Input voltages

	U_i	I_i	P_i	C_i	L_i
U1 (5)	8.7 V	250 mA	1.2 W	–	–
U2 (10)	12.7 V	330 mA	2.0 W	50 nF	–

Interface signals

	U_i	I_i	P_i	C_i	L_i
RXD (6)	15 V	74 mA	0.8 W	10 nF	–
TXD (7)	15 V	74 mA	0.8 W	10 nF	–

Output values of weighing cell connection

	U_o	I_o	P_o	C_o	L_o
(EX+)	8 V	250 mA	1.2 W	100 nF	300 μ H

5.3 Dimensional drawing

Metric terminal box

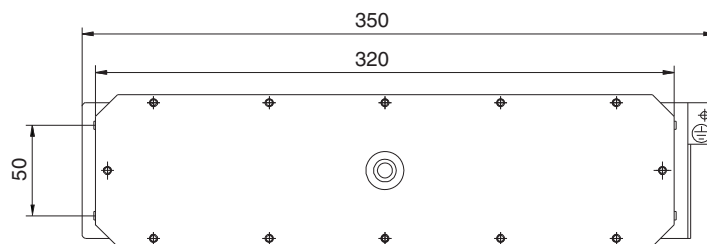
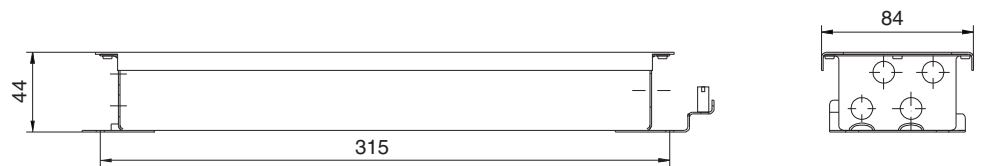

Dim. in mm

6 Accessories

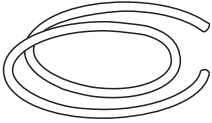
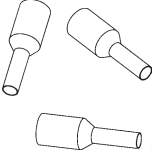
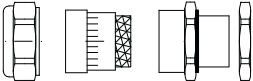
Graphic	Designation	Order No.
	Cable For intrinsically safe circuits, Ex-i 3 x 2 x 0.75 mm ² , shielded, 100 m	00 504 638
	Wire end ferrules H 0.75 / 13, with plastic collar , 100 pcs.	00 504 639
	Cable coupler M16 x 1.5 EEx e II, 6 pcs.	22 006 708

For spare parts, see the service manual of the Point A/D converter.

7 Disposal



In conformance with the European Directive 2002/96/EC on Waste Electrical and Electronic Equipment (WEEE), this device may not be disposed of in domestic waste. This also applies to countries outside the EU as per their specific regulations.

→ Please dispose of this product in accordance with local regulations at the collecting point specified for electrical and electronic equipment.

If you have any questions, please contact the responsible authority or the distributor from which you purchased this device.

Should this device be passed on to other parties (for private or professional use), the content of this regulation must also be related.

Thank you for your contribution to environmental protection.



22010342C

Subject to technical changes © Mettler-Toledo (Albstadt) GmbH 11/03 Printed in Germany 22010342C

Mettler-Toledo (Albstadt) GmbH

D-72458 Albstadt

Tel. ++49-7431-14 0, Fax ++49-7431-14 232

Internet: <http://www.mt.com>