

Semi-micro and Analytical Balance

L F Series

Operation Manual

IMPORTANT

- To ensure safe and proper use of the balance, please read this manual carefully.
- After reading this manual, store it in a safe place near the balance, so you can review it as needed.

SHINKO DENSHI CO., LTD.

Preface

Thank you very much for choosing the LF series balance.

This balance has an automatic calibration (span adjustment) function, which can be easily used at any time at the press of a button. The balance also has a function that alerts the user of when it is time to calibrate the balance depending on the surrounding environment. This enables you to calibrate the balance at the right time depending on your usage.

In addition, the balance comes standard with ISO/GLP/GMP compliant output functions, a calendar and clock function, and various application measurement functions, such as the counting mode, percentage weighing mode and addition mode.

The balance is easy to use, with a windshield that can be opened from the opposite side (the right door with the left knob and vice versa) and a weighing chamber that can be easily removed along with the windshield doors and the bottom plate for easy cleaning.

Instructions

- This manual is copyrighted by SHINKO DENSHI CO., LTD. and may not be reproduced in part or in whole without permission.
- Please understand that part of this manual may not agree with the product due to modifications or other such changes to it.
- Descriptions in this manual are subject to change without notice.
- This manual is created with all possible care. However, in the unlikely event of an incorrect description or any other errors, please tell us.
- If any pages are bound in incorrect order or are missing, we will replace the manual. Please contact the retailer from whom the balance was purchased.
- Trouble with the equipment and the system's main unit will be serviced in accordance with their maintenance contracts. However, please be aware that we will not be held responsible for any indirectly related trouble that may occur such as operations being stopped due to the trouble of the main unit.
- **ViBRA** is the registered trademark of SHINKO DENSHI CO., LTD. The company names and product names described in this manual are either their trademarks or registered trademarks.

Important Notice









- **You must be aware that the balance can potentially be dangerous. Be sure to follow this manual when you install and operate the balance, and perform maintenance and inspection.**
- **SHINKO DENSHI CO., LTD. takes no responsibility for any injury or damage caused because you did not follow this manual or the balance was incorrectly used or modified without permission.**

- In today's industrial equipment industry, potential risks are increasing due to new materials, process methods, and faster machines. It is impossible to predict all situations that pose such threats. In addition, there are too many "do's" and "do not's," to be able to cover them all in this manual. If the operation manual does not explicitly say that something is OK to do, please interpret it as a "do not." When installing or operating the balance, or performing maintenance or inspections on it, give due consideration to safety measures in addition to the instructions written in this manual and those written on the balance's main unit.
- This manual is copyrighted by SHINKO DENSHI CO., LTD. All rights reserved. Do not reproduce or disclose drawings and technical documents without prior written consent from SHINKO DENSHI CO., LTD.
- If you have any questions about this manual or you need more detailed information, please have the model name (type) and the manufacture number ready and contact the retailer from whom the balance was purchased.

How to Use This Manual

■ Symbols in this manual

Understand the meanings of the following symbols to follow the instructions in this manual:

Symbol	Meaning
	This symbol indicates a dangerous situation that may cause death or serious injury if not avoided.
	This symbol indicates a situation that may cause damage to the system or equipment, or data corruption, deletion, or overwriting if not avoided.
	This symbol is used for information to which particular attention is required, or to highlight information.
	This symbol is used for information such as operational tips.
	This symbol indicates a prohibited action that must not be done.
	This symbol indicates a mandatory action that must be executed without fail.

■ How to Read This Manual

This manual comprises the following chapters:

Chapter 1 How to Begin	This chapter gives introductory information such as how to assemble and install the balance, and how to turn the power on and off. Be sure to read this chapter the first time you use the balance.
Chapter 2 Basic Operation	This chapter gives basic instructions on how to weigh objects. The procedures for setting the functions used to set various functions are also described.
Chapter 3 Various Measuring Methods	This chapter describes how to use various measuring methods of the balance, such as counting and percentage weighing.
Chapter 4 Adjusting the Balance	The balance needs to be adjusted depending on where and when it is used. This chapter describes how to calibrate and test the balance.
Chapter 5 Setting the Functions	This chapter describes how to set the functions of the balance, such as setting units and readability.
Chapter 6 Input/Output to/from External Devices	This chapter describes printing to printers and how to input and output to and from RS-232C devices in detail.
Chapter 7 Troubleshooting	This chapter describes how to troubleshoot problems occurring with the balance, including actions required for errors, and remedies to problems.
Appendixes	The appendixes contain required data including the specifications of the balance.

■ Notational Conventions

In this manual, the following notation is used.

The balance	Refers to an LF series product.
[On/Off] key	The names of the operation keys provided on the front of the main unit are enclosed in brackets [].
“Func”	Messages shown on the display are enclosed in quotation marks “ ”.
Press the key.	Refers to pressing a key once.
Press and hold the key.	Refers to pressing and holding down the operation key until the desired display is obtained.

Contents

Preface	i
Important Notice.....	iii
How to Use This Manual	iv
Contents	vi
1 How to Begin	1
1-1 Warnings regarding Use.....	1
1-2 For More Precise Measurements.....	4
1-2-1 Precautions on the Measuring Room	4
1-2-2 Precautions on the Samples.....	5
1-3 Checking Supplied Items	6
1-4 Names and Functions of Component Parts	7
1-5 Functions of Operation Keys	8
1-5-1 Operation keys	8
1-5-2 Operation key explanations	8
1-6 How to Read Displayed Signs	10
1-7 Assembling and Installing the Balance.....	12
1-8 Operating the Windshield Doors	13
1-8-1 Opening and closing the windshield doors	13
2 Basic Operation	15
2-1 Powering On/Off and Operation Check	15
2-2 Zero-point Adjustment.....	17
2-3 Weighing a Sample in a Container (Tare).....	18
2-4 Weighing an Added Sample.....	19
2-5 Displaying the Sum of the Container and the Sample	20
2-6 Basics of Function Settings.....	21
2-7 Underfloor Measurement	22
3 Various Measuring Methods	23
3-1 Simple Weight Measurement.....	23
3-2 Counting the Number of Parts	24
3-2-1 Displaying the average sample weight	25
3-3 Measuring Percentage.....	27
3-3-1 Setting a reference weight by weighing an actual sample	27
3-3-2 Setting a reference weight by entering a value.....	28

3-4 Obtaining Weight Multiplied by a Coefficient.....	30
3-5 Measuring Specific Gravity	32
3-5-1 Specific gravity measurement procedure.....	32
3-5-2 Preparing measurement tools.....	32
3-5-3 Measurement	33
3-5-4 When using a liquid other than water	35
3-5-5 Printing the specific gravity data.....	36
3-6 Adding Multiple Measurements.....	37
3-6-1 Addition function settings.....	37
3-6-2 Weighing with the addition function	38
3-7 Judging between Too Heavy and Too Light (Limit Function).....	40
3-7-1 Limit function settings	44
3-7-2 Judgment using definite values	45
3-7-3 Judgment using deviation values	47
3-8 Statistical Operation Function	49
3-8-1 Calculation items	49
3-8-2 Operation method.....	50
3-8-3 Output of statistical operation results.....	52
3-8-4 Cancellation of last collected data	53
3-8-5 Clearing statistical operation results	54
4 Adjusting the Balance	55
4-1 Adjusting (Calibrating) the Balance.....	55
4-1-1 Span adjustment with internal weight	55
4-1-2 Span test with internal weight.....	56
4-1-3 Span adjustment with external weight	57
4-1-4 Span test with external weight	58
4-2 Calibrating the Internal Weight.....	59
4-3 Entering the Instrumental Error of a Weight for Use	62
4-4 Se-CAL (full automatic calibration function).....	63
4-5 Repeatability Measurement	64
4-5-1 Automatic Repeatability Measurement (ARM).....	64
4-5-2 Semi-Automatic Repeatability Measurement (SARM).....	65
4-6 Easy RES Function (single-touch response time change).....	67
5 Setting the Functions.....	69

5-1 Select and Switch of Weighing Units	69
5-2 Readability Setting	70
5-3 Automatic Switching of Scale Intervals	71
5-4 Turning ON/OFF the Automatic Switching of Scale Intervals with a Single Touch	72
5-5 Saving the Container (Tare) Weight	73
5-6 Power Setting	74
5-6-1 Automatic backlight-off function	74
5-7 Date and Time Setting	75
5-7-1 Time setting	75
5-7-2 Date setting	76
5-8 Date View	76
5-9 Time Output	77
5-10 Interval Output Function.....	78
5-11 ID No. Setting.....	80
5-12 Improving the Stability of the Balance.....	81
5-13 α -Check(self-diagnosis function)	83
5-13-1 Display test.....	83
5-13-2 Key test	84
5-13-3 Motor test	85
5-13-4 Span adjustment history	86
5-13-5 Automatic Repeatability Measurement (ARM).....	87
5-13-6 Semi-Automatic Repeatability Measurement (SARM).....	88
6 Input/Output to/from External Devices	89
6-1 Output to Printers.....	89
6-1-1 Connecting a printer	89
6-1-2 Printing span adjustment and span test results	89
6-1-3 Printing measurement results.....	90
6-2 Connection of interface and the external equipment.....	91
6-2-1 Connector pin numbers and functions of the D-SUB9P.....	91
6-2-2 Examples of connection with a PC	92
6-2-3 Connecting a type-B USB connector to a PC	93
6-2-4 Interface specifications	94
6-3 Communication Data and Commands	95
6-4 Output Data	95

6-4-1 Data format.....	96
6-4-2 Meanings of data.....	97
6-4-3 Communication format examples.....	100
6-4-4 Special formats.....	100
6-5 Input Commands.....	104
6-5-1 Procedure for transmission.....	104
6-5-2 Input command examples.....	104
6-5-3 Command format.....	105
6-5-4 Format of each command.....	105
6-6 Response.....	110
7 Troubleshooting.....	111
7-1 Error Messages.....	111
7-2 Troubleshooting.....	114
7-3 Initializing.....	117
7-4 Maintenance.....	118
7-4-1 For heavy dirt.....	118
7-4-2 How to clean the balance.....	119
Appendixes.....	121
Appendix 1 Function Setting List.....	121
Appendix 2 Measurement Mode List.....	130
Appendix 3 ISO/GLP/GMP Compliant Printing.....	131
Appendix 4 Specifications.....	136
Appendix 4-1 Basic Specifications.....	136
Appendix 4-2 Functional Specifications.....	137
Appendix 4-3 Weighing Capacity and Readability by Unit.....	138
Appendix 4-4 Unit Conversion Table.....	139
Appendix 4-5 Outline Drawings.....	140
Index of Terms.....	141

1 How to Begin

1-1 Warnings regarding Use

 **WARNING**

	<p>■ Do not disassemble or modify the balance. Doing so could result in injury, electric shock, fire and other accidents or failures. For inspection and adjustment, contact the retailer from whom the balance was purchased.</p>
	<p>■ Do not move the balance with a sample placed on the weighing pan. The sample could fall from the weighing pan and break or injure someone.</p>
	<p>■ Do not plug the AC adapter cord or the communication cable into the balance when the connector or jack is wet. Doing so could result in electric shock, short circuit or failure.</p>
	<p>■ Do not touch the AC adapter with wet hands. Doing so could result in electric shock, causing disability or death.</p>
	<p>■ Do not route the AC cord across passages. The cord could be tripped on by a passerby and the balance could fall down and break or injure someone.</p>
	<p>■ Do not use the balance on an unstable platform or in a place subject to vibration. A sample could fall from the weighing pan and break or injure someone. In addition, the balance could fail to accurately weigh samples.</p>
	<p>■ Only use the AC adapter specifically designed for the balance. Using any AC adapter other than the specified adapter could cause overheating, fire or failure.</p>
	<p>■ Only use the specified power supply. Using any power supply other than that specified could cause overheating, fire or failure.</p>



CAUTION

	<p>■ Do not apply excessive force to or impact the balance. Doing so could damage or result in failure of the balance. Carefully place samples on the balance.</p>
	<p>■ Do not allow the balance to remain in an overloaded state (o-Err indication). Doing so could damage or result in failure of the balance. Remove the sample immediately.</p>
	<p>■ Do not use volatile solvents. The main unit could deform. Wipe the main unit using dry cloth or a cloth moistened with a small amount of neutral detergent.</p>

ANNOTATION

	<p>■ Do not install the balance in a place where it is directly exposed to airflow from air-conditioning or heating equipment. Due to changes in the ambient temperature, the balance could fail to accurately weigh samples.</p>
	<p>■ Do not install the balance in a place exposed to direct sunlight. The internal temperature of the balance could rise and the balance could fail to accurately weigh samples.</p>
	<p>■ Do not install the balance where the floor is soft. When a sample is placed on the balance, the balance could slant and fail to accurately weigh samples.</p>
	<p>■ Do not install the balance in a place where the ambient temperature or humidity change significantly. The balance could fail to accurately weigh samples. Use the balance at an ambient temperature of 10 to 30°C and a relative humidity of 80% or lower.</p>
	<p>■ Do not install the balance on an unstable platform or in a place subject to vibration. The balance could fail to accurately weigh samples. In addition, a sample could fall off the weighing pan and injure someone.</p>
	<p>■ Do not install the balance on an inclined surface. The balance could fail to accurately weigh samples due to errors caused by the inclination. Install the balance on a level surface.</p>

ANNOTATION

	<p>■ After turning the balance on, leave it unused for more than 5 hours to acclimate it to the surrounding environment.</p> <p>Failure to do so could result in measurement errors. To ensure accurate measurements, be sure to acclimate the balance to the environment with the power on.</p>
	<p>■ Adjust (calibrate) the balance when it is installed or relocated.</p> <p>Failure to do so could result in measurement errors. To ensure accurate measurements, be sure to adjust (calibrate) the balance.</p>
	<p>■ Unplug the AC adapter from the receptacle when the balance is not going to be used for a long period of time.</p> <p>Unplug the balance from the receptacle to save energy and prevent degradation.</p>

1-2 For More Precise Measurements

To be able to conduct more precise measurements, it is necessary to minimize the factors that contribute to measurement errors. There are a great variety of such error-inducing factors, which can be linked to machine error and performance of the balance itself, as well as the properties and condition of samples being measured, and the measuring environment (e.g., vibration, temperature/humidity). These factors can readily affect the results of measurement on a balance that has high resolution readability.

This material includes some precautionary notes that the user should bear in mind to eliminate error factors and ensure accurate measurement results.

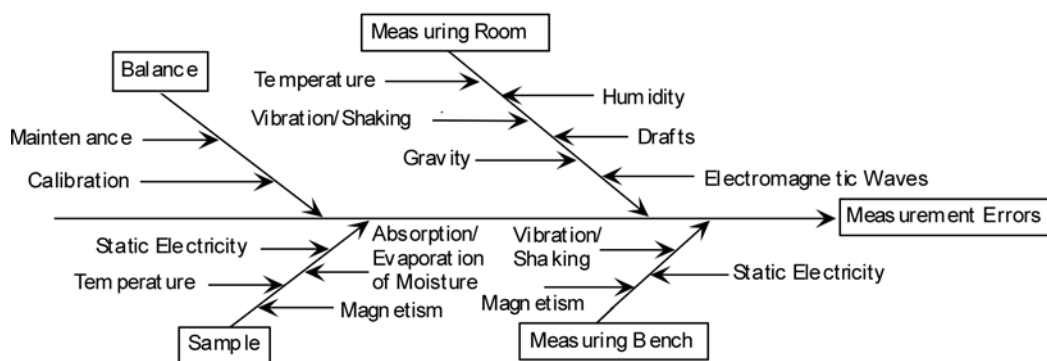

Factor Analysis Chart for Measurement Errors

1-2-1 Precautions on the Measuring Room

Temperature / Humidity	<ul style="list-style-type: none"> Try to maintain constant room temperature as much as possible to prevent dew condensation and unstable indications due to fluctuations in temperature. Low relative humidity tends to induce static electricity, causing measurement error. (Relative humidity of about 60% is considered ideal.)
Vibration / Shaking	<ul style="list-style-type: none"> The measuring room should preferably be located on the ground floor or in the basement. Higher floors are more susceptible to heavy vibration and shaking, which make such locations less suitable for measurement. A room facing a railway or road with heavy traffic should also be avoided as much as practicable.
Drafts	<ul style="list-style-type: none"> Avoid choosing a location subject to a direct draft of airflow from an air-conditioning unit or exposed to direct sunlight, which may cause unstable reading due to abrupt fluctuations in temperature. Also avoid a room subject to a heavy flow of people, since fluctuations in drafts and temperature are likely to occur in such a location.
Gravity	<ul style="list-style-type: none"> The gravity acting on a sample varies depending on the latitude or height of the location where measurement is being conducted. For this reason, the same sample may show different weight indications from one place to another. Therefore, make it a rule to calibrate the balance every time it is relocated.
Electromagnetic Waves	<ul style="list-style-type: none"> When the balance is located near an object that generates intense electromagnetic waves, it may be hindered from showing accurate weight due to the effects of such waves. Therefore, avoid placing the balance in such a location.

1-2-2 Precautions on the Samples

Static Electricity	<ul style="list-style-type: none"> • Generally speaking, objects made of synthetic resin and glass have high electric insulating properties and, therefore, are apt to be electrically charged. Measuring a charged sample as is may cause unstable indications, with resultant poor reproducibility of the results. With this in mind, be sure to discharge charged samples before measurement.
Magnetism	<ul style="list-style-type: none"> • A sample affected by magnetism indicates different weight values depending on where it is located on the measuring pan, along with resultant poor reproducibility of the results. When a magnetized sample must be measured, first demagnetize it or place an appropriate pedestal on the measuring pan to adequately separate the mechanism part of the balance from the magnetized sample for avoiding the effects of magnetism.
Absorption / Evaporation of Moisture	<ul style="list-style-type: none"> • Measuring a sample with moisture absorbed or evaporated (volatized) continuously increases or decreases the values indicated. In such case, measure the sample in a container with a small opening and sealed airtight with a cap.
Sample Temperature	<ul style="list-style-type: none"> • A difference in temperature between a sample and the interior of a windshield may cause convection to occur inside the windshield, resulting in erroneous measurement. Therefore, measure a very hot or cold sample only after allowing time for its temperature to acclimatize to room temperature. Moreover, to prevent convection inside the windshield, allow time for the interior of the windshield to acclimatize to room temperature. • The body heat of a person conducting measurement can also affect measurement results. Avoid holding the sample with bare hands, and use long tweezers or a similar tool instead. Also refrain from putting your hands inside the windshield while measurement is in progress.

1-3 Checking Supplied Items

The following items are in the box.

In the unlikely event of problems such as missing or broken items, please contact the retailer from whom the balance was purchased.

Checking Supplied Items

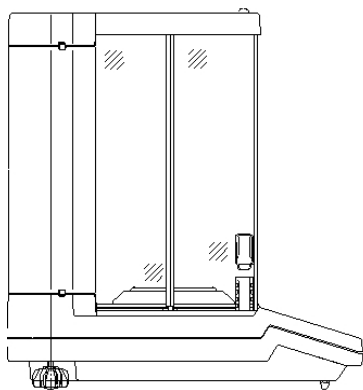

Main unit of balance



Measurement pan



Pan base



windshield ring

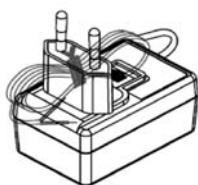

AC adapter

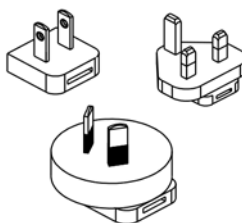

Adapter plug

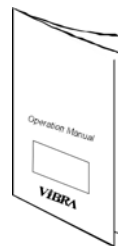

Operation Mnual

Installing the adapter plug

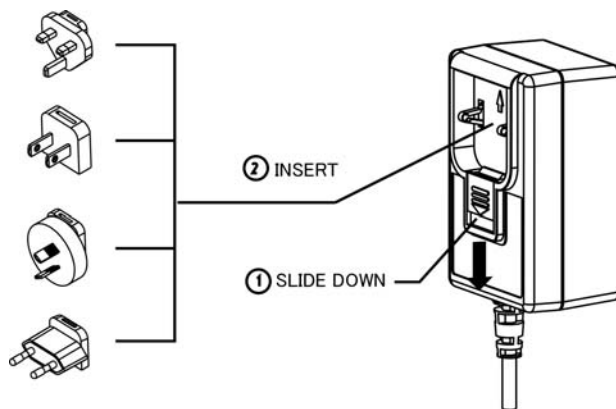

1-4 Names and Functions of Component Parts

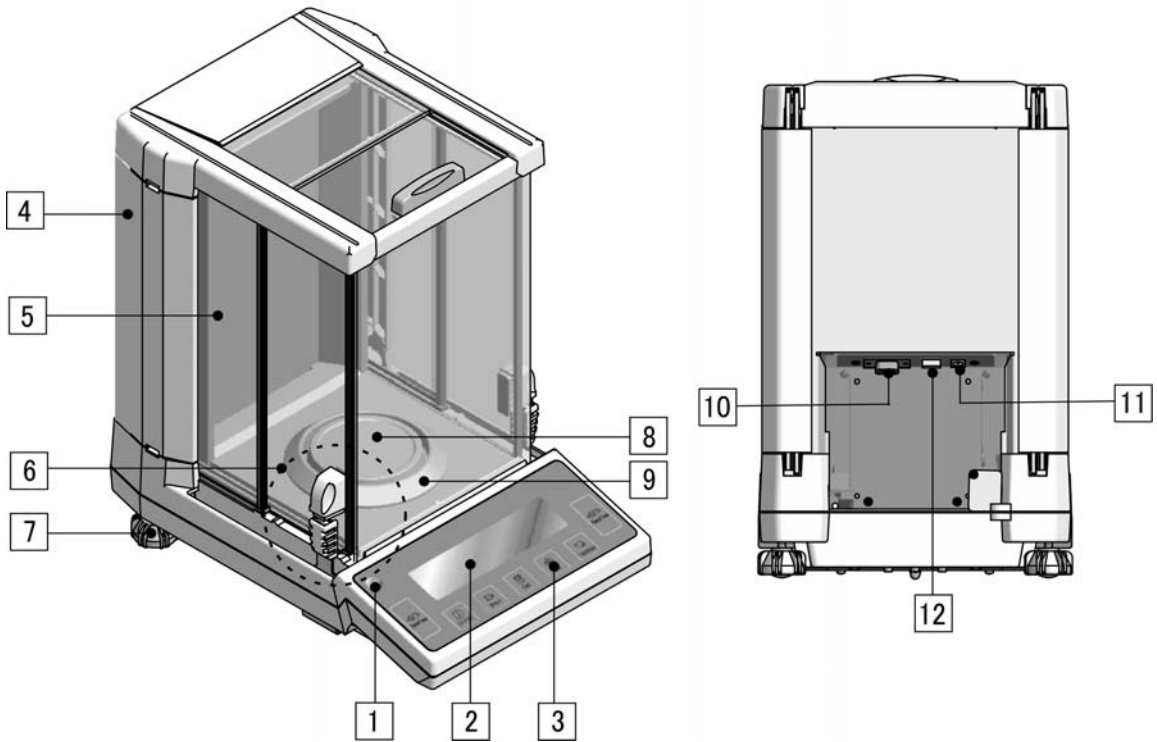

Names of Component parts			
1	Level	7	Adjuster
2	LCD	8	Measurement pan
3	Panel section	9	Windshield ring
4	Door storage cover	10	D-SUB9P RS232C output connector
5	Windshield	11	AC adapter jack
6	Knob	12	USBoutput connector





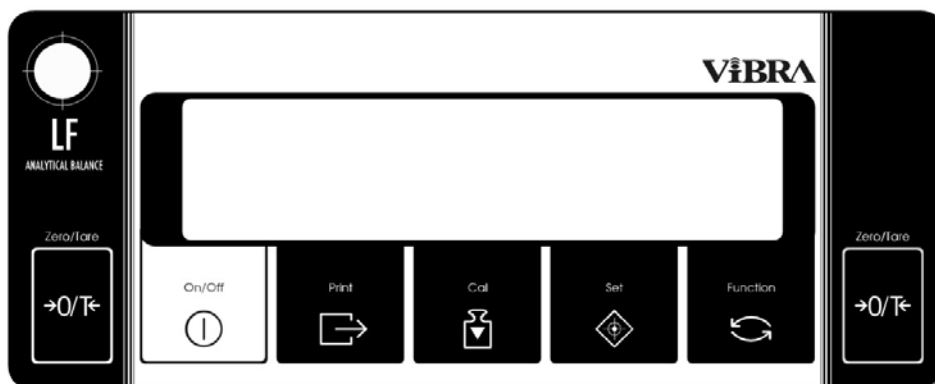

1-5 Functions of Operation Keys

The operation keys are located on the front of the main unit. Use these keys to operate and set the balance.

1-5-1 Operation keys



1-5-2 Operation key explanations

Operation key		Function
[On/Off] key		Used to power on/off the balance.
[Print] key		Used to start printing. Used to interrupt settings and inputs.
[Set] key		[Press] to turn ON/OFF the automatic switch between two scale intervals. [Press] to save settings. [Press and hold] to start making settings.
[Cal] key		[Press] to call span adjustment and span test. [Press and hold] to start an automatic repeatability measurement.
[Function] key		[Press] to switch measurement modes. [Press] to make settings by entering values. [Press] to select items for function settings. [Press and hold] to call functions.
[Zero/Tare] key		[Press] to set the zero point or change the readout to zero using the tare. [Press] to set a value by entering the value. [Press] to select functions.

How to press keys

The functions of some operation keys depend on how they are pressed.

For example, the [Set] key saves a setting when it is pressed quickly. (This is the normal way of pressing keys.)

Reference

The [Set] key starts making a setting when it is pressed and held.



Pressing and holding a key is to hold the key down and then release it once the desired display has been obtained.

1-6 How to Read Displayed Signs

Each of the symbols displayed on the front of the main unit has the following meanings:

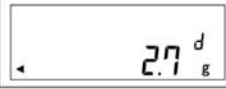

Display	Description
	Displays the judgment results when the (five-point) limit function is enabled.
*	Displayed when the balance is in standby mode. Indicates that the addition function is enabled for accepting an additional load.
○	Indication of stable balance (If this light is off, the balance is unstable.)
+	Sign for sample addition when parts counting is performed
-	Minus
M	Display of set values from memory (If it is flashing, the value is being saved.)
→0←	Zero-point
	Bar graph (Refer to Hints on page 44).
CAL	Displayed when calibration and Advice CAL are enabled.
	Lights up when date/time is being set or displayed. Blinks during interval output.
	Displayed when data is output in compliance with ISO/GLP/GMP.
B/G	Gross weight
Net	Tare sign
#	Unit converting
Σ	Displays a sum total.
Pcs	Parts counting
mom	Momme
%	Percentage weighing
	Displays the selected unit.
mg	Milligram, gram
▲, ►	Displayed according to the function.

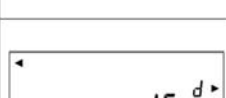
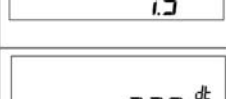
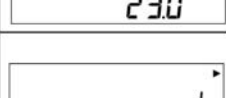
	Indicates that the balance is in gravimeter mode.
	Indicates that the midair weight has been saved in gravimeter mode.
	Indicates that the specific gravity (no units) is being displayed in gravimeter mode.
	Indicates that the volume (unit: cm ³) is being displayed in gravimeter mode.
	Indicates that the actual water temperature (unit: °C) is being entered in gravimeter mode.
	Indicates that the density of a medium (unit: g/cm ³) is being entered in gravimeter mode.

7-segment character display

Numeric characters

1	2	3	4	5	6	7	8	9	0
<i>1</i>	<i>2</i>	<i>3</i>	<i>4</i>	<i>5</i>	<i>6</i>	<i>7</i>	<i>8</i>	<i>9</i>	<i>0</i>

Alphabet

A	B	C	D	E	F	G	H	I	J	K	L	M
<i>A</i>	<i>b</i>	<i>C</i>	<i>d</i>	<i>E</i>	<i>F</i>	<i>G</i>	<i>H</i>	<i>I</i>	<i>J</i>	<i>K</i>	<i>L</i>	<i>M</i>

N	O	P	Q	R	S	T	U	V	W	X	Y	Z
<i>n</i>	<i>o</i>	<i>P</i>	<i>q</i>	<i>r</i>	<i>S</i>	<i>t</i>	<i>u</i>	<i>v</i>	<i>W</i>	<i>X</i>	<i>Y</i>	<i>Z</i>

 CAUTION	Some characters look the same, for example, “5” and “S,” and “H,” “K,” and “X.”
---	---

1-7 Assembling and Installing the Balance

(1) Attach the windshield ring, the pan base, and the weighing pan, in this order, to the main unit. Check that these parts are free from dust and other foreign matter before attaching them.

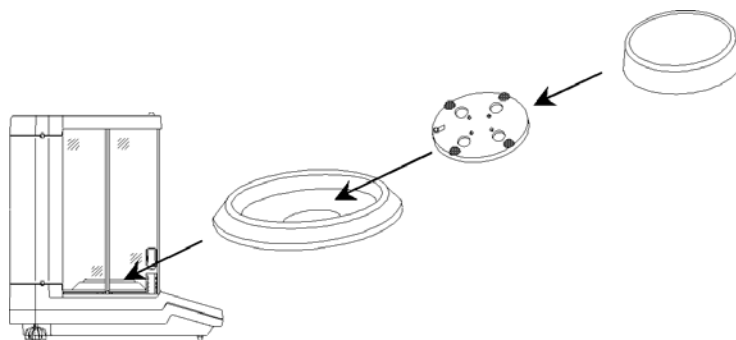

(2) Install the balance horizontally. Rotate the adjuster so that the level bubble is positioned in the center of the red circle.

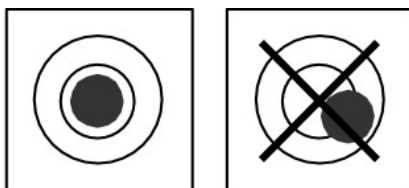

Correct Position of the Level Bubble

(3) Connect the supplied AC adapter to the balance and plug it into the receptacle (100 VAC).

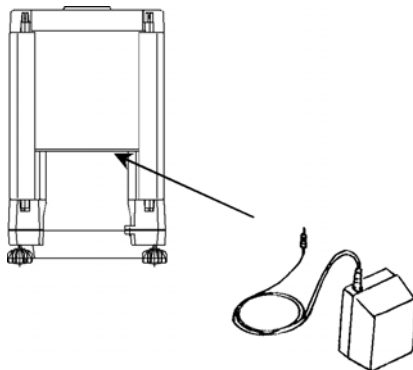

1-8 Operating the Windshield Doors

The left and right windshield doors can be opened and closed by using the upper and lower knobs on both sides of the windshield. Two knobs are used on either side; one is secured on the door (upper knob), and the other can be slid up and down (lower knob). Each windshield door can be locked (LOCK) and unlocked (RELEASE) by moving the lower knob up or down to lock or unlock, allowing for windshield operation that suits the conditions, such as whether the user is left- or right-handed and the way a sample is placed on the weighing pan.

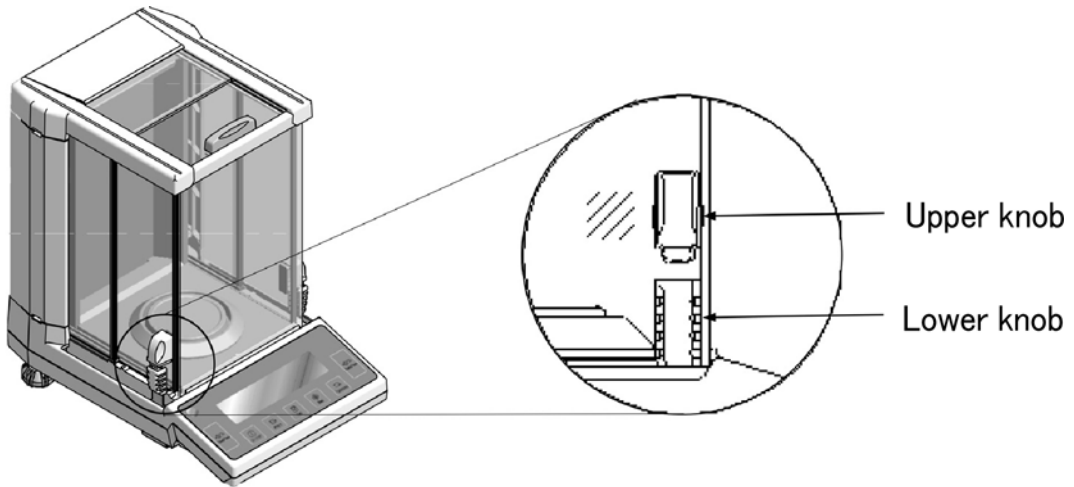

1-8-1 Opening and closing the windshield doors

■ Opening and closing the right and left windshield doors at the same time

The right and left windshield doors can be opened and closed at the same time by operating knob on either side.

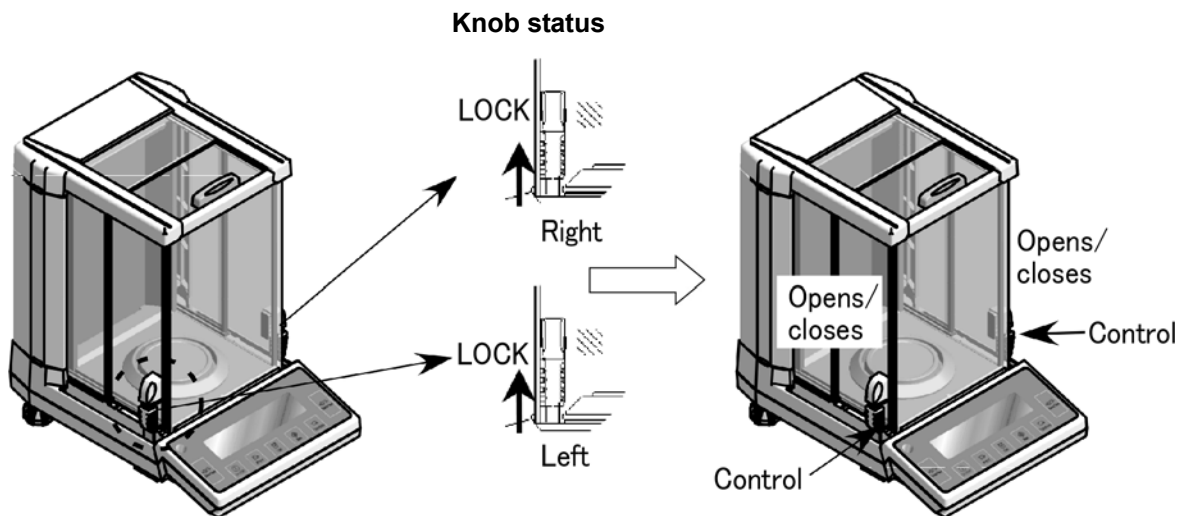

■ **Opening and closing the right windshield door**

The right windshield door can be opened and closed by operating the left lower knob.

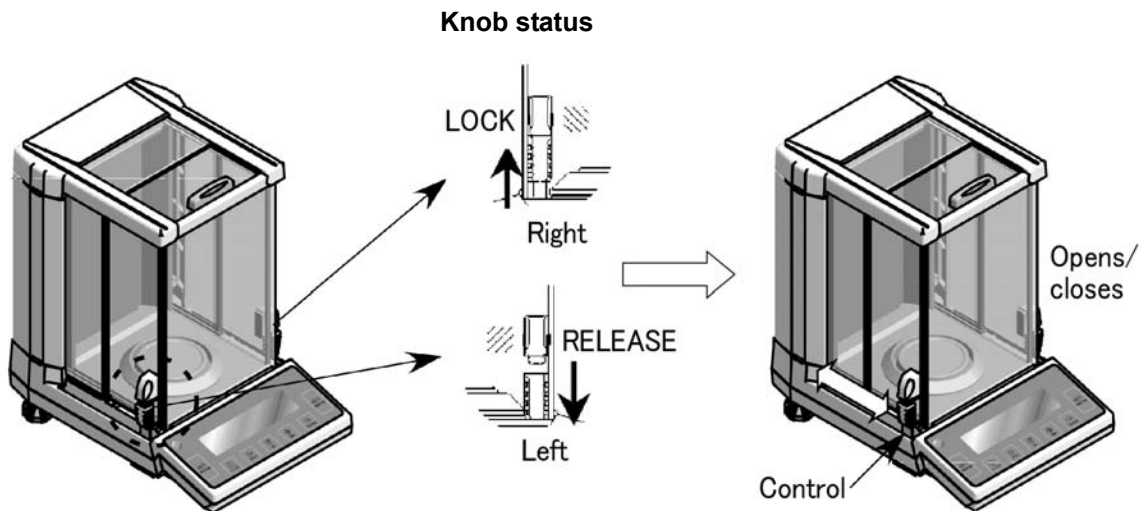

■ **Opening and closing the left windshield door**

The left windshield door can be opened and closed by operating the right lower knob.

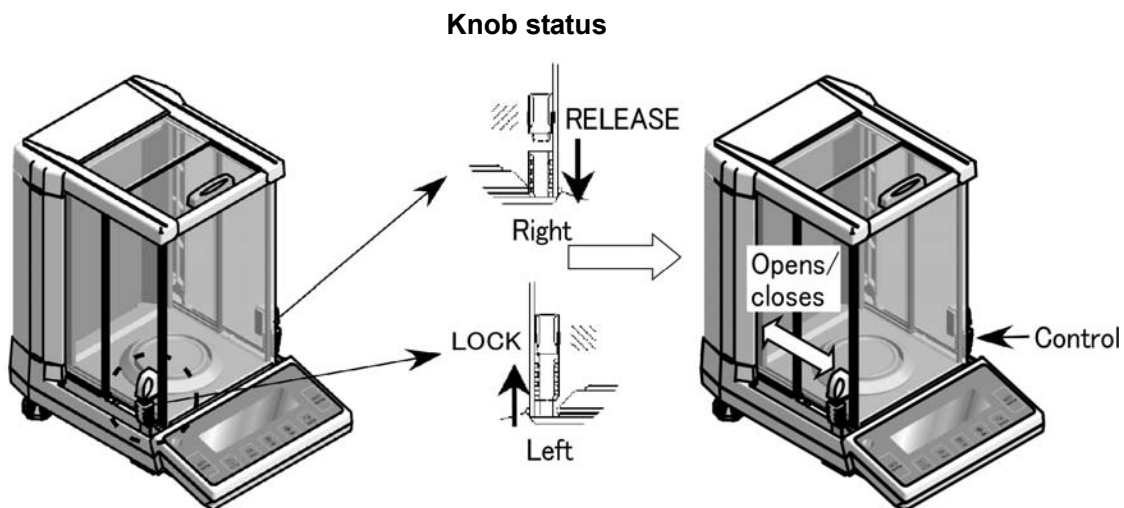

* To open and close the left and right windshield doors individually, push the left and right lower knobs down to unlock. Use the upper knobs to open and close the doors.

2 Basic Operation

2-1 Powering On/Off and Operation Check

Turning the balance ON/OFF

1

Turn the balance ON.



Standby state

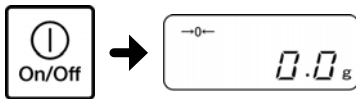

Check that the AC adapter is connected to the balance.

When the AC adapter is plugged in, the balance enters the standby state and an asterisk “*” appears.

Leave the balance powered on with the asterisk “*” displayed for 5 hours before starting measurement. If you unplug the AC adapter, you need to wait for 5 hours from the time you plug it in again.

Press the [On/Off] key.

The display shows all symbols and then changes to the zero display.

2

Check that it is operating.



Push the weighing pan with your finger to check that the readout changes.

Also check that the readout changes to zero when you stop pushing.

3

Turn the balance OFF.

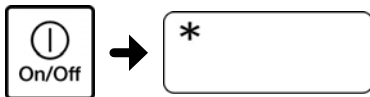

Standby state

Press the [On/Off] key again.

The balance enters the standby state.

-
- When the balance is turned ON, it is in the same measurement mode as when it was turned OFF. For example, if the balance was turned OFF in counting mode, when it is turned ON it is still in counting mode.
 - When the balance is stabilized, the display shows a circle "O."



Reference

When the balance is unstable, the circle "O" disappears. The balance may be affected by wind or vibration.

- The bar graph also appears on the display. It shows the current weight level compared to the weighing capacity. As the weight approaches the weighing capacity of the balance the bar graph moves toward the right end.



2-2 Zero-point Adjustment

Zeroing a deviated readout is called “zero-point adjustment.”

1 Examine the surface of the weighing section. Check that nothing is on the weighing section.

2 Execute zero-point adjustment.

Press the [Zero/Tare] key.

The readout becomes zero and the “→0←” mark appears.

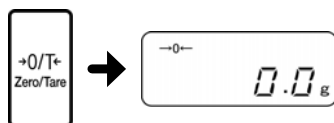

- Zero-point adjustment may not be possible if an object is on the weighing section. In such cases, refer to Section 2-3 “Weighing a Sample in a Container (Tare)” and perform “tare range setting.”

Reference

- Whether the balance waits until it is stabilized for zero-point adjustment can be set using the function item “wait for the balance to stabilize.”

When “Operate after waiting for the balance to stabilize” is set, the “**M**” indicator blinks while waiting for the balance to stabilize. While the “**M**” indicator is blinking, make sure that the balance is not subjected to wind or vibration.

2-3 Weighing a Sample in a Container (Tare)

When weighing a sample in a container (tare), only the sample is weighed by subtracting the mass of the container. This is called “tare.”

- 1 Place the container on the weighing pan.

The mass of the container is displayed.

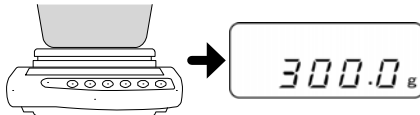

- 2 Set the tare.

Press the [Zero/Tare] key.

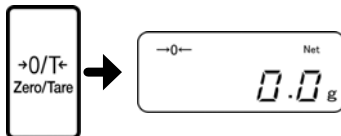

The readout becomes zero and “→0←” and “Net” are displayed (tare range setting).

CAUTION

If “Net” does not appear when the [Zero/Tare] key is pressed, the balance is executing zero-point adjustment, not tare range setting.

- 3 Place a sample in the container.

Only the mass of the sample is displayed.

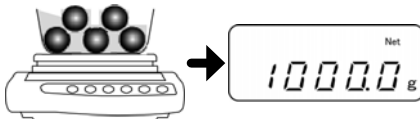

Reference

When setting the tare range, the weighable range is reduced by the mass of the tare (set tare).

Weighable range = original weighing capacity – set tare

2-4 Weighing an Added Sample

Place an additional sample on the balance. Only the addition is measured.

1

Put a sample in place.

The mass of the sample is displayed.

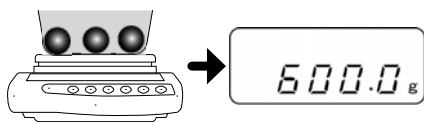

2

Set the tare.

Press the [Zero/Tare] key.

The readout becomes zero (tare range set).

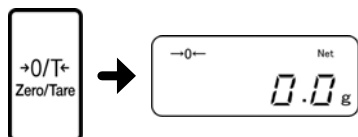

3

Place the next sample on the balance.

Only the mass of the added sample is displayed.

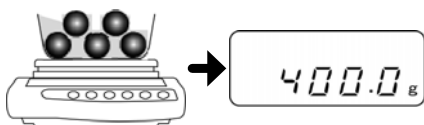

2-5 Displaying the Sum of the Container and the Sample

The summed weight of the sample and the container is displayed (gross weight readout).

	<p>Gross weight can only be displayed when the balance is in simple weight measurement mode. For more information on simple weight measurement mode, refer to the section on "Weighing."</p>
---	--

- Put a container in place and then set the tare.

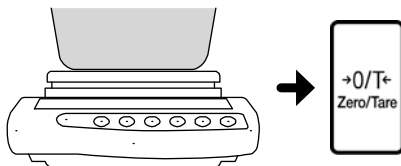

(Example: tare range = 300.0 g)

Put a container in place and press the [Zero/Tare] key.

The tare range is set and the readout becomes zero.

("Net" lights up when the tare range is being set.)

- Put a sample in place.

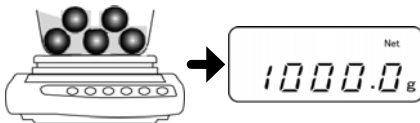

The mass of the sample alone (net weight) is displayed.

- Display the gross weight (Gross weight readout).



Press the [Function] key.

The summed weight (total weight) of the sample and the container is displayed (gross weight readout). "B/G" lights up when the gross weight is being displayed.

Pressing the [Function] key toggles the readout between gross and net.



Net weight readout Gross weight readout

[Function] key

2-6 Basics of Function Settings

Use the Function key to change the balance's settings.
 This section describes the basic operations for setting functions.

1 Go to the function setting mode.

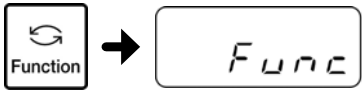

Release the key when the display changes.

Press and hold the [Function] key. After "Func" is displayed, release the key.
 The first function item is then displayed.

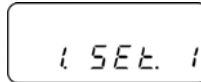

If you continuously hold the [Function] key, the function setting mode will change to another mode. If this happens, press the [Print] key to cancel the setting and do this step over again.

2 Select an item to set.

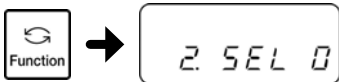

Press the [Function] key to select the item to be set.

Example: Press the [Function] key once and select "2.SEL" (additional functions). The first setting "2.SEL 0" is displayed.

3 Select a setting.

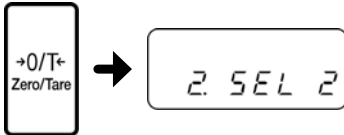

Press the [Zero/Tare] key to select the setting.

The next setting is displayed every time the [Zero/Tare] key is pressed. The first setting is displayed again if the [Zero/Tare] key is pressed when the last setting is displayed.

Example: Press the [Zero/Tare] key twice to select "2.SEL 2."

4 Save the setting.



Press the [Set] key to finish making settings.

The balance returns to the weight display.
 To cancel making settings, press the [Print] key.

Refer to Appendix 1 "Function Setting List" for available function items and settings.

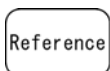

To return the function settings to their default values, refer to Section 7-3 "Initializing."

When you are in the middle of making a function setting, you can press the [Print] key to cancel the setting and return to measurement mode.

2-7 Underfloor Measurement

This balance has a hook for underfloor measurement. You can weigh samples by hanging a bottom pan or the like from the hook. Use underfloor measurement for weighing samples of ferromagnetic substances, samples having strong static electricity and other samples that cannot be accurately weighed on the weighing pan.

- 1 Unplug the AC adapter from the receptacle. Fully open all doors and remove the weighing pan, the pan base, the windshield ring, and the bottom plate. Remove the bottom plate by holding both sides and lifting it up.

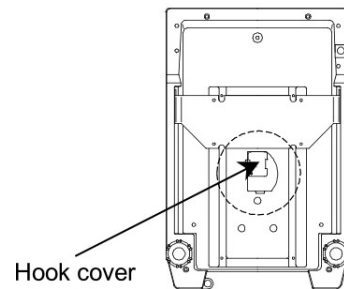

- 2 Slowly turn the balance and lay it on its back.

- 3 Loosen the hook cover screw, and rotate the hook cover around the screw by 90 degrees to the right.

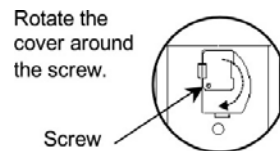

- 4 Retighten the screw.

- 5 Put the bottom plate, the windshield ring, the pan base and the weighing pan back in place. Close all the windshield doors.

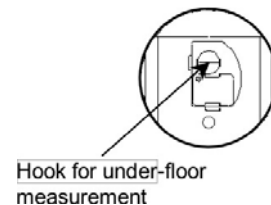

- Parts such as a bottom pan are included in the tare range, so the balance cannot measure to its full weighing capacity.
- Keep the hook cover closed to prevent dust from entering the balance, unless it is used for underfloor measurement.
- When opening and closing the windshield doors with a bottom pan or the like hanging from the balance, loosen the knobs and use the upper knobs to open and close the doors.



3 Various Measuring Methods

3-1 Simple Weight Measurement

By default, the balance is set to simple weight measurement mode. To return to simple weight measurement mode from other weighing modes, perform following operations.

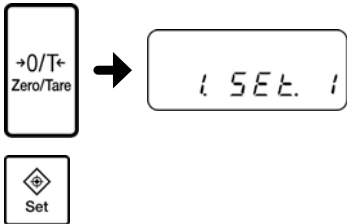
- 1 Go to function setting mode.
(Refer to Section 2-6 "Basics of Function Settings.")
Press and hold the [Function] key until "Func" is displayed.
"1. SET" is displayed.
- 2 Select simple weight measurement mode.
Press the [Zero/Tare] key several times to select "1.SET 1."

- 3 Press the [Set] key.
The setting is saved and the display returns to showing the sample's weight.

3-2 Counting the Number of Parts

The balance saves the weight of a sample (unit weight) using the automatic memory update method (simplified SCS method) to count the number of samples.

First, put a set number of samples in place. Next, put up to three times the set number of additional samples in place. The balance will automatically update the average sample weight. Repeating this step allows accurate counting.

1 Go to the function setting mode.
(Refer to Section 2-6 "Basics of Function Settings.")

Press and hold the [Function] key until "Func" is displayed.

2 Select counting mode.

Press the [Zero/Tare] key several times to select "1. SET 2."

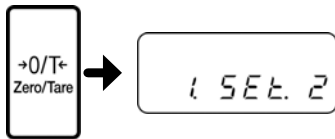

3 Save the mode.

Press the [Set] key.

The balance is set to counting mode and "Pcs" is displayed.



4 Start sampling.

Press and hold the [Function] key until "U. SET" is displayed.

The display reads "on 10 Pcs" which indicates that ten samples will be used.



<Press and hold>

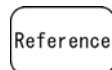

Pressing the [Print] key during sampling cancels the sampling.

5 Select the number of samples.

A sample count can be chosen by repeatedly pressing the [Zero/Tare] key which cycles through the sample counts: 5, 10, 30, and 100.



If the samples vary considerably in size or are light in weight, set a greater number of samples.

6 Weigh the samples.

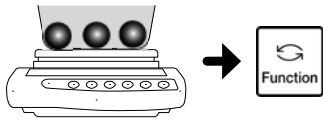

Place the set number of samples on the weighing pan and then press the [Function] key.

The displayed sample quantity (Example: “on 10 Pcs”) blinks.

7 Add more samples.

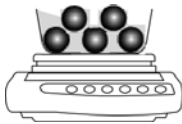

Add more samples. The number of additional samples can be up to three times the set number of samples.

For example, if “10 Pcs” is set, add 30 or less samples.

A beep notifies you that added samples have been measured.

Repeating this sample addition step improves the counting accuracy.

8 Finish sampling.



Press the [Function] key.

The average sample weight is saved and the balance returns to displaying the number of samples.

9 Put samples in place to count them.

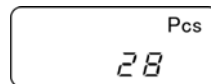

Pressing the [Function] key toggles the display between the number of samples, the average sample weight, and the total weight.

3-2-1 Displaying the average sample weight

Pressing the [Function] key toggles the display between the number of samples, the average sample weight, and the total weight.

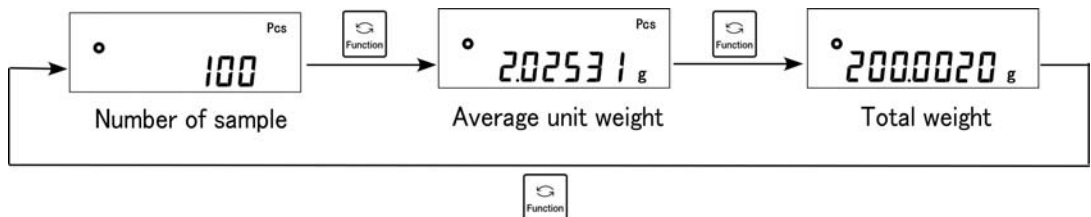

Reference

- If “Sub” is displayed, it indicates that you added more than three times as many samples as the set number. Decrease the number of additional samples. Starting from a small number of samples, gradually increase the number of samples to increase counting accuracy.
 - If “Add” is displayed, it indicates that the number of added samples is too small. Increase the number of additional samples.
 - Sampling is possible even when “Sub” or “Add” is displayed. However, counting accuracy will be low.
 - If [L-Err] is displayed, it indicates that the average sample weight is smaller than the weighable unit weight.
-
-

3-3 Measuring Percentage

The weight of a sample is shown as a percentage of the reference sample weight. A reference sample weight can be set by weighing an actual sample (setting a reference weight by weighing an actual sample) or entering a value (setting a reference weight by entering a value).

3-3-1 Setting a reference weight by weighing an actual sample

- 1** Go to the function setting mode.
(Refer to Section 2-6 "Basics of Function Settings.")

Press and hold the [Function] key until "Func" is displayed.
- 2** Select percentage weighing mode.

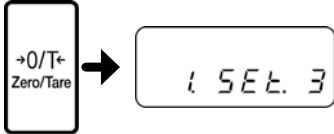

Press the [Zero/Tare] key several times to select "1. SET 3."
- 3** Save the mode.



Press the [Set] key.
The percentage weighing mode is set and "%" is displayed.
- 4** Start measuring the reference sample weight.

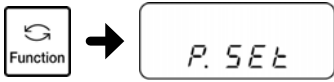

Press and hold the [Function] key. After "P. SET" is displayed, release the key.
The previously saved reference sample weight blinks.
- 5** Save the reference sample weight.

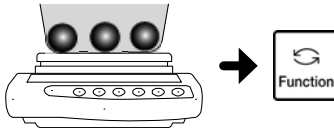

Put the reference sample on the balance and then press the [Function] key.
The reference weight is saved.
- 6** Weigh a sample.



The display indicates the percentage of the sample to the reference sample weight.
Pressing the [Function] key toggles the display between percentage weight and total weight.

3-3-2 Setting a reference weight by entering a value

- 1** Go to the function setting mode.
(Refer to Section 2-6 "Basics of Function Settings.")

Press and hold the [Function] key until "Func" is displayed.
- 2** Select percentage weighing mode.

→0/T←
Zero/Tare

→

1.5 E L 3

Press the [Zero/Tare] key several times to select "1. SET 3."
- 3** Save the mode.

Set

→

0 %

Press the [Set] key.
The percentage weighing mode is set and "%" is displayed.
- 4** Start measuring the reference sample weight.

Function

→

P. SET

<Press and hold>

Press and hold the [Function] key. After "P. Set" is displayed, release the key.
The previously saved reference sample weight blinks.
- 5** Enter the value of a reference sample weight.

→0/T←
Zero/Tare

→

→0/T←
Zero/Tare

→

Function

Set a reference weight with the following steps:

 - (1) Press the [Zero/Tare] key.
The rightmost digit will blink.
 - (2) Press the [Zero/Tare] key to select a number.
Pressing the key toggles the number between 0 and 9, and the decimal point.
 - (3) Press the [Function] key to move to the next digit, which will then start blinking.

Set the reference sample weight by repeating steps (2) and (3).

Press the [Print] key to cancel the setting.
- 6** Save the reference sample weight.

Set

Press the [Set] key to save the reference sample weight.
- 7** Weigh a sample.

The display indicates the percentage of the sample to the reference sample weight.
Pressing the [Function] key toggles the display between percentage weight and total weight.

- The readability is automatically set based on the saved reference weight.

Reference

Readability	Range of Reference Weight
1%	Lower weight limit \leq Reference weight $<$ Lower weight limit \times 10
0.1%	Lower weight limit \times 10 \leq Reference weight $<$ Lower weight limit \times 100
0.01%	Lower weight limit \times 100 \leq Reference weight

- The “L-Err” display indicates that the reference weight is below the lower weight limit, which means that weighing is impossible. For more information on the weight limit in percentage weighing, refer to Appendix 4-2 “Functional Specifications.”

3-4 Obtaining Weight Multiplied by a Coefficient

Measured weight is multiplied by a set coefficient, and the result be displayed.

For example, if “2.35” is set for the coefficient, and the weight of the sample is “2000 g,” the given readout is “4700.”

(Example) Sample (2000 g) × Coefficient (2.35) → Readout (4700)

- 1** Go to the function setting mode.
(Refer to Section 2-6 “Basics of Function Settings.”)

Press and hold the [Function] key until “Func” is displayed.
- 2** Select unit conversion mode.

Press the [Zero/Tare] key several times to select “1. SEt 4.”

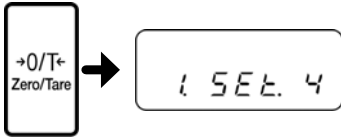
- 3** Save the mode.

Press the [Set] key.

The unit conversion mode is set and “#” is displayed.

- 4** Go to the coefficient setting mode.

Press and hold the [Function] key until “C. SEt” is displayed.

The previously saved coefficient is displayed.



<Press and hold>
- 5** Enter a coefficient.

Set a coefficient with the following steps:

 - (1) Press the [Zero/Tare] key.
 - The rightmost digit will blink.
 - (2) Select a number by pressing the [Zero/Tare] key.
 - Pressing the key toggles the number between 0 and 9, and the decimal point.
 - (3) Press the [Function] key to move to the next digit, which will then start blinking.

Set the coefficient by repeating steps (2) and (3).

Press the [Print] key to cancel setting the coefficient.

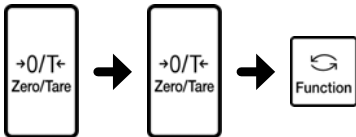

6

Save the coefficient.



Press the [Set] key.

7

Weigh a sample.



The weight of the sample is multiplied by the coefficient,
and the result is displayed.

Reference

The increment of the readability is automatically set to 1, 2, or 5 depending on the entered coefficient.

3-5 Measuring Specific Gravity

Use either underfloor measurement or the optional specific gravity measurement kit to measure specific gravity. When using underfloor measurement, you need a cage or net in which to place a sample, string, a container, and other tools depending on the sample you are going to measure.

* Function 1 is “1 SEt. 5” (Solid gravimeter).

Set “11. MEd.” to “0: water” or “1: Not water” depending on the medium you will use.

3-5-1 Specific gravity measurement procedure

Measure the specific gravity according to the following procedures:

- (1) Prepare measurement tools
- (2) Set the water temperature or the specific gravity of the liquid
- (3) Weigh the sample in air
- (4) Correct the error of the basket
- (5) Weigh the sample in water
- (6) The specific gravity value is displayed

3-5-2 Preparing measurement tools

Prepare the following tools and a sample. (Tools must be procured by users.)

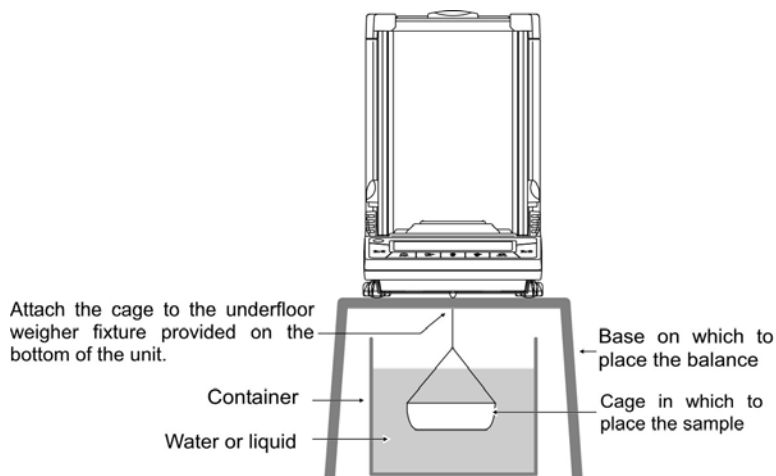

The balance may fail to accurately weigh small samples. Use as large a sample as possible.

Reference

To accurately measure the specific gravity, set the water temperature. Measure the water temperature inside the container in advance.

3-5-3 Measurement

1 Go to the function setting mode.
(Refer to Section 2-6 “Basics of Function Settings.”)

Press and hold the [Function] key until “Func” is displayed.

2 Select gravimeter mode.

Press the [Zero/Tare] key several times to select “1.SET 5.”

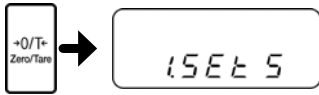

3 Save the mode.

Press the [Set] key.

The gravimeter mode is set and “d” is displayed.



4 Go to the water temperature setting mode.

Press and hold the [Zero/Tare] key.

(When using any liquid other than water, refer to the section on “When using a liquid other than water.”)

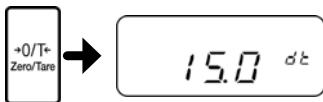

<Press and hold>

5 Set the temperature of water in the container.

Set the water temperature with the following steps:

Start the water temperature setting with the highest-order digit and then sequentially set lower-order digits.

(1) Press the [Zero/Tare] key.

The rightmost digit will blink.

(2) Select a number by pressing the [Zero/Tare] key.

Pressing the key toggles the number between 0 and 9, and the decimal point.

(3) Press the [Function] key to move to the next digit,

which will then start blinking.

Reference

Set the water temperature by repeating steps (2) and (3).

- When using a liquid other than water, refer to page 35 and set the medium.
- When using a liquid other than water, set the density.
- The set values remain saved even after the balance is turned off.
- The water temperature can be set to between 0 and 99.9°C.
- Press the [Print] key to cancel the setting.

6

Save the water temperature.

Press the [Set] key.



7

Hang the cage only and set the weight readout to zero.

Hang only the cage from the underfloor weighing hook.

Press the [Zero/Tare] key.

The readout changes to zero.

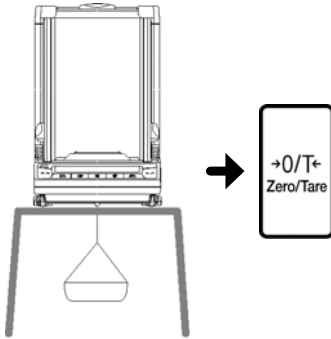

8

Weigh a sample.

Place a sample in the cage.

When the weight readout is stabilized, press the [Set] key.

This saves the weight of the sample in the air.

Once the weight is saved, "•" is shown in the lower left corner of the display.

You can also weigh the sample on the weighing pan.

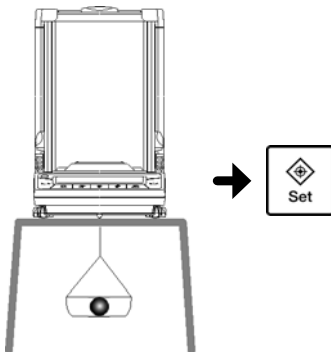

9

Set the liquid container in place.

Place the container with water under the balance, and put only the cage into the water. (Do not put the sample in the cage.)

Press the [Zero/Tare] key to change the readout to zero.

This eliminates the discrepancy caused by the cage.

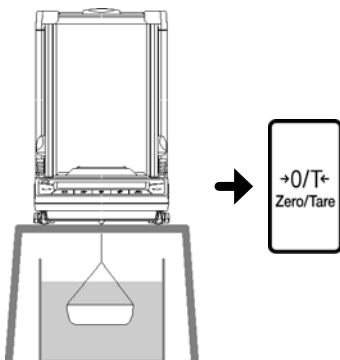

10 Place the sample in the cage.

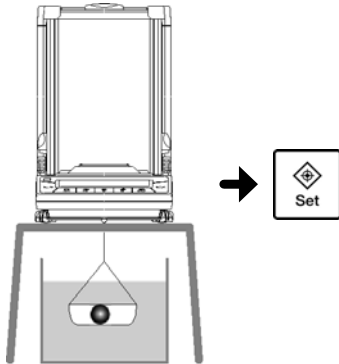

Place the sample in the cage and immerse the sample fully in the water.

When the weight readout is stabilized, press the [Set] key.

The measured specific gravity value is displayed.

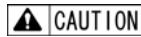

Keep the cage away from the liquid container.

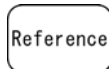

Pressing the [Function] key toggles the display between the specific gravity and the volume. Press the [Set] key to return to the weight display.

3-5-4 When using a liquid other than water

1 Go to the function setting mode.
(Refer to Section 2-6 “Basics of Function Settings.”)

Press and hold the [Function] key until “Func” is displayed.

2 Select gravimeter mode.

Press the [Zero/Tare] key several times to select “1.SET 5.”

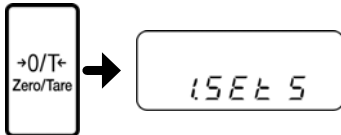

3 Go to the medium selection mode.

Press the [Function] key.
“11.MEd.” is displayed.



4 Select the “Not water” setting.

Press the [Zero/Tare] key to select “1” (Not water), and press the [Set] key.

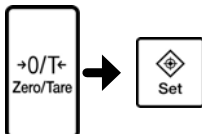

Now the balance can measure the specific gravity using any liquid other than water. Measure the specific gravity with the steps described in “Measurement” (page エラー! ブックマークが定義されていません。). In step 5, set the density of the liquid you are using, instead of the water temperature. The liquid density can be set to between 0.0001 and 9.999 g/cm³.

3-5-5 Printing the specific gravity data

To output the measured specific gravity data to a printer, perform the following operations depending on settings.

- Before measurement
Press the [Print] key to print data (whether the balance is stable or unstable), regardless of the “71. o.c.” (output control) function setting.
- When specific gravity is displayed
You can change the output details and method by changing the “12. d.o.d.” (output data selection) and “13. A.o.” (automatic output) function settings.
- Print format
When the “12. d.o.d.” (output data selection) function setting is set to “1” (specific gravity, weight, actual water temperature or medium density), all data are output. (See the figures below.)
When the “12. d.o.d.” (output data selection) function setting is set to “0” (only specific gravity), only the first and second lines in the figures below are printed.
When statistical operation is conducted with a printer, a serial number is added before the numerical value of the second line in the figures below.
Set the language used for printing with the “G3.P.F.” (print characters) function setting. (Set 1 for English or 2 for Japanese.)

Examples of printed specific gravity data

When water is selected

English

```
DENSITY SOLID
      2.7513
SAMPLE WEIGHT
      21.4705 g
TEMPERATURE NOW
      15.0 c
VOLUME/cm3
***
```

Japanese (katakana)

```
コタイヒシ°ユウ
      2.7513
シ°ユクリヨウ
      21.4705 g
シ°ツスイオン
      15.0 c
タイセキ/cm3
***
```

When other than water is selected

English

```
DENSITY SOLID
      2.4147
SAMPLE WEIGHT
      30.0023 g
DENSITY MED. LIQ
      1.325
VOLUME/cm3
      10.2198
```

Japanese (katakana)

```
コタイヒシ°ユウ
      2.4147
シ°ユクリヨウ
      30.0023 g
ハ°イタイヒシ°ユウ
      1.325
タイセキ/cm3
      10.2198
```

3-6 Adding Multiple Measurements

Multiple samples are weighed consecutively and the sum is displayed.

You can choose to replace samples (cumulate function) for each addition or leave the previous samples on the scale as you add more (net addition function).

The addition function can be used in simple weight measurement mode, the counting mode, the percentage weighing mode and the unit conversion mode.

3-6-1 Addition function settings

1 Go to the function setting mode.
(Refer to Section 2-6 "Basics of Function Settings.")

Press and hold the [Function] key until "Func" is displayed.

2 Select the addition function.

Press the [Function] key several times to select "2. SEL."
Press the [Zero/Tare] key to select "2. SEL 1."

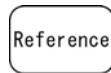
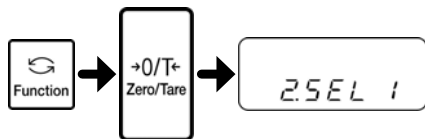

When using both the cumulate and limit functions together, select "2. SEL 3."

For more information on the limit function, refer to Section 3-7 "Judging between Too Heavy and Too Light (Limit Function)."

3 Select cumulate or net addition.

Press the [Function] key. After "2C.Add." is displayed, press the [Zero/Tare] key to set the value.

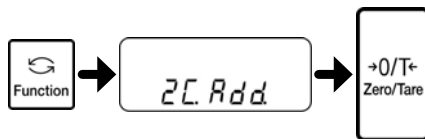

- 1: Cumulate function
- 2: Net addition function

Details of "2C.Ad."

[1: Cumulate function] Continue measurements by replacing samples after each addition.

[2: Net addition function] Continue measurements by adding samples without replacing them after each addition. The balance automatically sets the tare range after each addition.

4 Finish making settings.

Press the [Set] key.



The addition function is set.

3-6-2 Weighing with the addition function

1 Put the first sample in place.

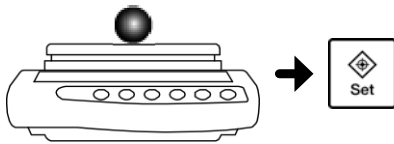

After an asterisk "*" is displayed, press the [Set] key.

The measured value is saved and a sigma "Σ" sign is displayed for several seconds. (The tare range is set automatically when net addition is selected.)

2 **Cumulate** Put another sample in place.

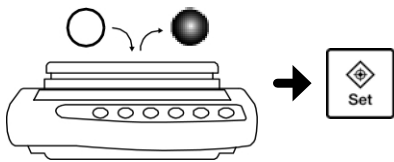

Unload the previous sample, check that the display indicates "0," and place the next sample.

After an asterisk "*" is displayed, press the [Set] key.

The sigma "Σ" sign and the cumulative weight are displayed for several seconds.

Repeat this operation to add measurements.

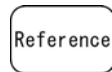

After adding a measurement, press the [Zero/Tare] key to set the tare range. By doing so, you can add another sample without removing the previous sample to add the next measurement.

Net addition Place an additional sample.

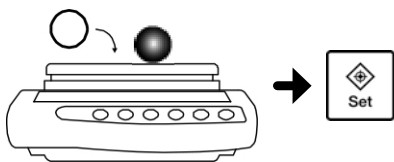

Add another sample. (The tare range is set automatically.)

After an asterisk "*" is displayed, press the [Set] key.

The sigma "Σ" sign and the cumulative weight are displayed for several seconds. Then the balance returns to the weight display and the tare range is set automatically.

Repeat this operation to add measurements.

3 Display the cumulative weight.



Press the [Function] key twice.

The "Σ" sign and the cumulative weight are displayed.

To clear the cumulative weight

Cumulate: Press the [Zero/Tare] key when the cumulative weight is displayed.

Net addition: Press the [Zero/Tare] key. (The cumulative weight is cleared whether the cumulative weight is displayed or not.)

After clearing the cumulative weight, press the [Function] key to return to the measurement mode. You can repeat the addition operation from step 1.

Reference

- If “t-Err” is displayed it indicates (1) you have attempted to add a measurement when a negative weight is displayed or (2) you have attempted to add measurements without replacing samples or setting the display to zero when the cumulate function is selected. You cannot add measurements in either case.
 - The function setting “L. tA.” can be used to turn ON/OFF the function to wait for stabilization after making additions.
(Refer to Appendix 1 “Function Setting List.”)
-

3-7 Judging between Too Heavy and Too Light (Limit Function)

You can set several limit values to be used to judge whether measurements are within the specified limits.

Reference	The limit function can be used in simple weight measurement mode, counting mode, percentage weighing mode and unit conversion mode.
-----------	---

■ Judgment method

According to the lower and upper limits you set, a measurement is judged to be too light (lower than the lower limit), within the appropriate range, or too heavy (higher than the upper limit), and the judgment result is displayed using the “◀” symbol.

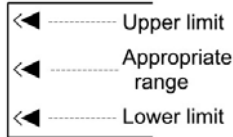
	Judgment result	1-point setting (lower limit)	2-point setting (upper & lower limits)
	Above the upper limit	Not displayed	Upper limit < Weight
	Appropriate	Lower limit ≤ Weight	Lower limit ≤ Weight ≤ Upper limit
	Below the lower limit	Weight < Lower limit	Weight < Lower limit

For a 3- or 4-point setting, “◀” appears on the display in 4 or 5 steps according to the judgment result.

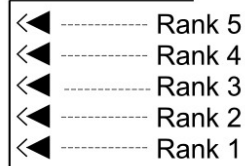
	Judgment result	3-point/4-point setting
	Rank 5 (4-point setting)	Point 4 ≤ Weight
	Rank 4	Point 3 ≤ Weight < Point 4
	Rank 3	Point 2 ≤ Weight < Point 3
	Rank 2	Point 1 ≤ Weight < Point 2
	Rank 1	Weight < Point 1

Depending on the number of judgment points, the “<” mark shown in the range indicated by “◀” appears at all times.

Reference

In 1-point setting, only the lower limit is set and is used for judging whether samples are “OK (appropriate range)” or “LO (too light).”

The judgment result can also be shown on a graph.

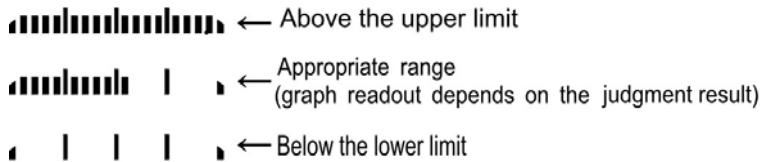

Set the function "2A.LG." to "2" (2-point bar graph). (Refer to Appendix 1 "Function Setting List.")

The bar graph display is available only with the 2-point setting.

■ Judgment criteria and limit value setting

One of the following criteria is used for judgment.

- Judgment using definite values: Upper-limit, lower-limit and other limit values by which to judge are specified.
- Judgment using deviation values: A reference weight and the range between its upper and lower limits are used to make judgment.

The following two methods are available to enter limit values.

- Setting a weight by weighing an actual sample: Weigh an actual sample on the balance and save the weight.
- Setting a weight by entering a value: Enter a value using the keys.

■ Detailed function settings

The limit function can be set to a specific value with the function settings.

When the function setting “2.SEL” is “2” or “3,” the following items can be set by pressing the [Function] key. Set these items as required.

☆ Initial setting

Condition	21.Co.	☆ 1: Always judge. 2: Judge only when the balance is stable.
Range to cover	22.Li	0: Detect when the limit is exceeded by more than five divisions. 1: Detect when the limit is exceeded by more than fifty divisions ☆ 2: Detect both when the limit is exceeded and when it is not reached.
Point scale	23.Pi	0: 1-point scale (OK and LO are judged.) 1: 1-point scale (HI and OK are judged.) ☆ 2: 2-point scale (HI, OK, and LO are judged.) 3: 3-point scale (Ranks 1 to 4 are judged.) 4: 4-point scale (Ranks 1 to 5 are judged.)
Judge using	24.tYP.	☆ 1: Judge using definite values 2: Judge using deviation values
Buzzer for rank 1	25.bu.1	☆ 0: The buzzer is not sounded for rank 1 (LO). 1: The buzzer is sounded for rank 1 (LO).
Buzzer for rank 2	26.bu.2	☆ 0: The buzzer is not sounded for rank 2 (OK). 1: The buzzer is sounded for rank 2 (OK).
Buzzer for rank 3	27.bu.3	☆ 0: The buzzer is not sounded for rank 3 (HI). 1: The buzzer is sounded for rank 3 (HI).
Buzzer for rank 4	28.bu.4	☆ 0: The buzzer is not sounded for rank 4. 1: The buzzer is sounded for rank 4.
Buzzer for rank 5	29.bu.5	☆ 0: The buzzer is not sounded for rank 5. 1: The buzzer is sounded for rank 5.

	<ul style="list-style-type: none"> • Separate limit values can be saved for each weighing mode. However, limit values of both definite and deviation values cannot be saved in the same weighing mode. • Limit values can be set only in measurement mode display (Cannot be set in other mode displays such as when a cumulative value is displayed). • Adjust the zero-point or set a tare range, as required, before setting limit values. • If the limit value entries are not lined up in the order of magnitude, three “◀” will light up. Enter the values again.
---	---

3-7-1 Limit function settings

First set the limit function and then set limit values.

- 1** Go to the function setting mode.
(Refer to Section 2-6 "Basics of Function Settings.")

Press and hold the [Function] key until "Func" is displayed.
- 2** Select the limit function.

Press the [Function] key several times to select "2.SEL."

Press the [Zero/Tare] key to select "2.SEL 2."

When using both the cumulate and limit functions together, select "2.Set. 3."

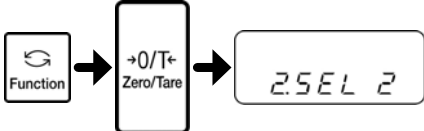
- 3** Set the judgment condition.

Press the [Function] key several times to select "21.Co."

Press the [Zero/Tare] key to select a judgment condition.

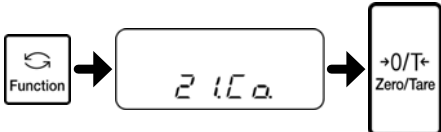
 - 1: Always judge (even when the balance is unstable)
 - 2: Judge only when the balance is stable.
- 4** Set the range to cover.

Press the [Function] key several times to select "22.Li."

Press the [Zero/Tare] key to select the range to cover.

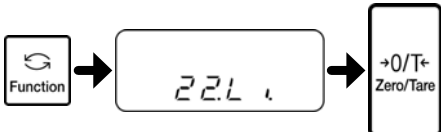
 - 0: Detect when the limit is exceeded by more than five divisions.
 - 1: Detect when the limit is exceeded by more than fifty divisions
 - 2: Detect both when the limit is exceeded and when it is not reached.
- 5** Set the point scale.

Press the [Function] key several times to select "23.Pi."

Press the [Zero/Tare] key to select a point scale.

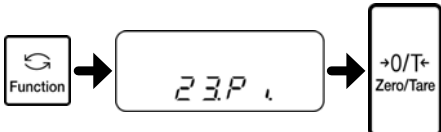
 - 0: 1-point scale (OK and LO are judged.)
 - 1: 1-point scale (HI and OK are judged.)
 - 2: 2-point scale (HI, OK, and LO are judged.)
 - 3: 3-point scale (Ranks 1 to 4 are judged.)
 - 4: 4-point scale (Ranks 1 to 5 are judged.)
- 6** Set the judgment method.

Press the [Function] key several times to select "24.tYP."

Press the [Zero/Tare] key to select a judgment method.

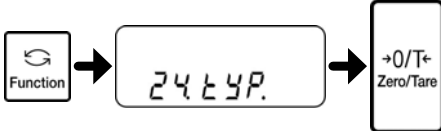
 - 1: Judge using definite values
 - 2: Judge using deviation values

7

Save the settings.

Press the [Set] key.



Next, set values for judgment (limit values) and take measurements.

3-7-2 Judgment using definite values

Use the function setting “24.tYP. 1” to judge samples using definite values.

■ Judgment using definite values by setting actual sample weights

Weigh a sample and set the upper-limit and lower-limit.

Check that the limit function for judgment using definite values is selected. (Refer to the previous section “Limit function settings.”)

1

Set to actual sample weight setting mode.

Press and hold the [Set] key until “L.SET” is displayed.



<Press and hold>

2

Weigh the sample serving as the lower limit.

Put the sample serving as the lower-limit in place and press the [Function] key.



For 1-point setting, this operation completes the setting save process. Proceed to step 4.
For 2-point setting, “H.SET” is displayed.

3

Weigh the sample serving as the upper limit.

Place the sample serving as the upper limit on the weighing pan and press the [Function] key.

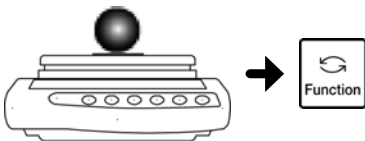

The values for judgment are saved and the balance returns to the weight display.

4

Weigh a sample.

Place the sample to be judged on the weighing pan.

The OK/LO/HI result judged according to the upper-limit and lower-limit is indicated by “◀”.

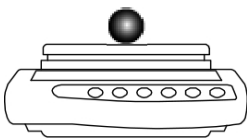

■ Judgment using definite values by entering values

Set the upper limit and the lower limit by using the keys.

Check that the limit function for judgment using definite values is selected. (Refer to the previous section “Limit function settings.”)

1 Set to actual sample weight setting mode.

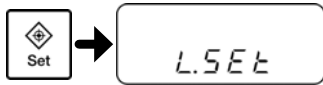

Press and hold the [Set] key until “L.SET” is displayed.

<Press and hold>

2 Enter the lower-limit value.

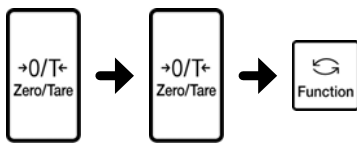

Enter the lower-limit value with the following steps:

- (1) Press the [Zero/Tare] key.
The rightmost digit will blink.
- (2) Select a number by pressing the [Zero/Tare] key.
Pressing the key toggles the number between 0 and 9, and the decimal point.
- (3) Press the [Function] key to move to the next digit, which will then start blinking.
- (4) Press the [Set] key to save the number.

For 1-point setting, this operation completes the setting save process. Proceed to step 4.
For 2-point setting, “H.SET” is displayed.

3 Enter the upper-limit value.

Enter the upper-limit value by doing the same operation as in step 2.

The values for judgment are saved and the balance returns to the weight display.

4 Weigh a sample.

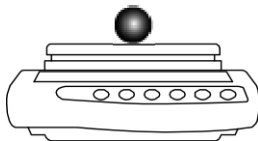

Place the sample to be judged on the weighing pan.

The OK/LO/HI result judged according to the upper-limit and lower-limit is indicated by “◀”.

3-7-3 Judgment using deviation values

Use the function setting “24.tYP.2” to judge samples using deviation values.

■ Judgment using deviation values by setting actual sample weights

Weigh a sample and set the reference weight, the upper-limit, and the lower-limit.

Check that the limit function for judgment using deviation values is selected. (Refer to the previous section “Limit function settings.”)

- 1** Go to the actual sample weight setting mode. Press and hold the [Set] key until “r.SET” is displayed.

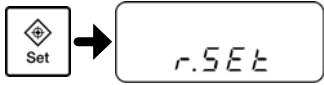

<Press and hold>
- 2** Weigh the sample serving as the reference weight. Put the sample serving as the reference weight in place and then press the [Function] key.

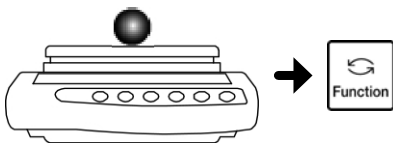
- 3** Weigh the sample serving as the lower limit. Place the sample serving as the lower-limit in place and press the [Function] key.

For 1-point setting, this operation completes the setting save process. Proceed to step 5.
For 2-point setting, “H.SET” is displayed.

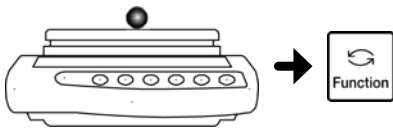
- 4** Weigh the sample serving as the upper limit. Place the sample serving as the upper limit on the weighing pan and press the [Function] key.

The values for judgment are saved and the balance returns to the weight display.

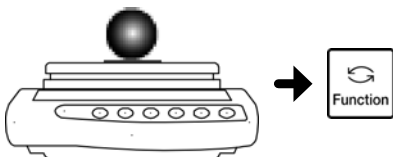
- 5** Weigh a sample. Place the sample to be judged on the weighing pan.

The OK/LO/HI result judged according to the upper-limit and lower-limit is indicated by “◀”.

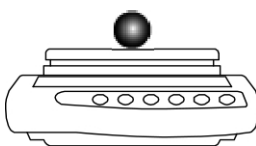

■ Judgment using deviation values by entering values

Set the reference weight, the upper limit, and the lower limit by using the keys.

Check that the limit function for judgment using deviation values is selected. (Refer to Section 3.7.1, “Limit function settings.”)

For judgment using deviation values by entering values, enter the difference between the upper limit and the lower limit with respect to the reference weight.

To perform a judgment with an upper-limit weight of 200 g and a lower-limit weight of 100 g, set the reference weight to 150 g, the upper limit value to 50 g and the lower-limit value to -50 g.

1

Go to the value entry mode.

Press and hold the [Set] key until “r.SET” is displayed.



<Press and hold>

2

Enter the reference weight.

Enter the reference weight with the following steps:

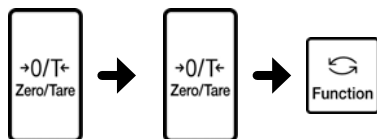

- (1) Press the [Zero/Tare] key.
The rightmost digit will blink.
- (2) Select a number by pressing the [Zero/Tare] key.
Pressing the key toggles the number between 0 and 9, and the decimal point.
- (3) Press the [Function] key to move to the next digit, which will then start blinking.
- (4) Press the [Set] key to save the number.

3

Enter the lower-limit value.

Enter the lower-limit value by doing the same operation as in step 2.

For 1-point setting, this operation completes the setting save process. Proceed to step 5.

For 2-point setting, “H.SET” is displayed.

4

Enter the upper-limit value.

Enter the upper-limit value by doing the same operation as in step 2.

The values for judgment are saved and the balance returns to the weight display.

5

Weigh a sample.

Place the sample to be judged on the weighing pan.

The OK/LO/HI result judged according to the upper-limit and lower-limit is indicated by “◀”.

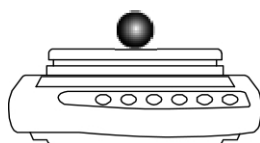

3-8 Statistical Operation Function

The statistical operation function collects weight data and displays maximum, average, and other statistical values.

3-8-1 Calculation items

Calculation item	Display example
Maximum value	
Minimum value	
Average value	
Standard deviation	
Width (Maximum – Minimum)	
Coefficient of variation	
Number of data items	
Sum total	

* The average value, standard deviation, and coefficient of variation are calculated using the following equations:

Reference

$$\text{Average value} = \frac{1}{N} \sum_{i=1}^N x_i ; \text{Standard deviation} = \sqrt{\frac{N \cdot \sum_{i=1}^N (x_i)^2 - (\sum_{i=1}^N x_i)^2}{N \cdot (N - 1)}} ; \text{and}$$

$$\text{Coefficient of variation} = \frac{\text{Standard deviation}}{\text{Average value}} \times 100(\%)$$

where x_i is the i th measured value and N is the number of data points.

3-8-2 Operation method

- 1** Go to the function setting mode.
(Refer to Section 2-6 “Basics of Function Settings.”)

Press and hold the [Function] key until “Func” is displayed.
- 2** Set the weighing mode to the statistical operation mode.

Press the [Function] key several times to select “1.SET.”
Press the [Zero/Tare] key to select “7.”

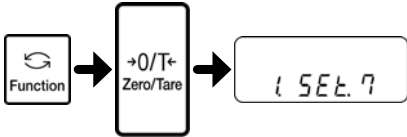
- 3** Save the statistical operation mode.

Press the [Set] key.

The statistical operation mode is set and “st” is displayed.

- 4** Collect data.

Put a sample in place and press the [Print] key.

Data is collected and then output.

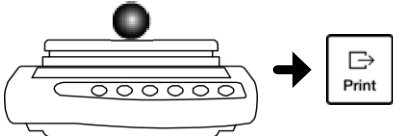

- 5** Collect more data.

Unload the previous sample, check that the display indicates “0,” and place the next sample. Collect data in the same way as in step 4.

Repeat placing a sample, collecting data, and removing the sample until the required number of data items are collected.
- 6** Display the statistical operation result.

Press the [Function] key.

The display changes to the statistical operation display.

- 7** Switch to another calculation item.

Press the [Set] key when the statistical operation display is active.

Pressing the [Set] key toggles the calculation item cyclically in the order shown in the table in Section 3-8-1 “Calculation items.”
- 8** Return to the weight display.

Press the [Function] key when the statistical operation display is active.

The balance returns to the weight display.

Reference

- Zero-point setting and tare range setting are important for accurate calculation of statistical values.
- To delete data, when incorrect data is mistakenly collected for example, refer to Section 3-8-4 “Cancellation of last collected data.”

CAUTION

- Zero or minus data cannot be collected and “9-Err” will be displayed.
- Statistical operation uses digits not shown in the weight display. Statistical operation results may differ from results of operation using readout values only.
- In step 4, pressing the [Print] key is required only when “71.o.c.7” is selected. When “71.o.c.4” is selected, data is output and collected automatically when the balance is stable. For the statistical operation function, the “71.o.c.” setting is valid when it is set to “4” or “7.” If it is set to other values, it is taken as “71.o.c.7.”
- When the number of data items exceeds 999 or the total exceeds the number of digits that can be displayed on the balance during data collecting, “9-Err” is displayed and the balance no longer performs operations. Clear the statistical operation result.

■ Tip for operation

Keys to operate for the statistical operation function are outlined below. Press the [Set] key to proceed to the next calculation item.

Statistical calculation display

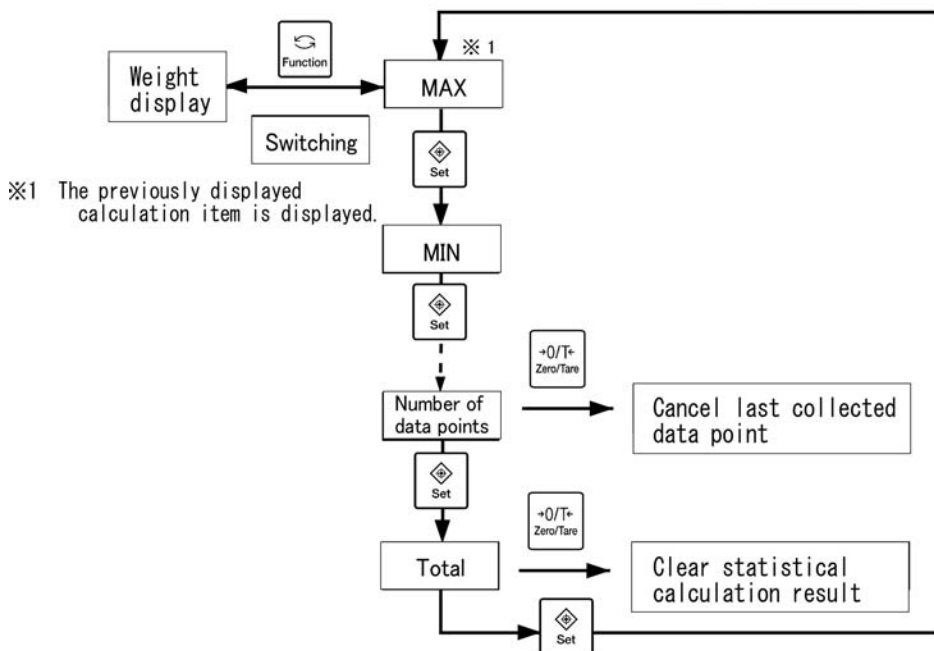

3-8-3 Output of statistical operation results

Statistical operation results are collectively output to devices.

1

Set to the statistical operation display.



Press the [Function] key when the balance is displaying the weight.

Do this before collecting the next data item.

2

Output the statistical operation results.



Press the [Print] key. At this time, it does not matter which calculation item is selected.

The statistical operation results are output.

Indication of operation result	Description
<RESULT>	Title
DATE:	Date when the operation result is output
TIME:	Time when the operation result is output
N	Number of data items
SUM	Sum total
MAX	Maximum value
MIN	Minimum value
R	Width (Maximum – Minimum)
AVE	Average value
SD	Standard deviation
CV	Coefficient of variation

Other indications	Description
CANCEL	Cancel last collected data
ALLCLR	Clear all statistical operation results

Reference

- How the year, month, and date are displayed depends on the “H.dAtE” setting.
- Whether the date and time is displayed in English or Japanese depends on the “G3.P.F.” setting.

3-8-4 Cancellation of last collected data

You can only cancel the data collected last.

1

Set to the statistical operation display.



Press the [Function] key when the balance is displaying the weight.

Do this before collecting the next data item.

2

Set the calculation item to "Number of data items."

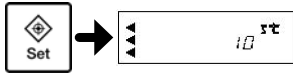

Press the [Set] key several times until the calculation item is set to "Number of data items."

When the calculation item is "Number of data items," three "(Insert the image of the black triangle on the left-hand side)" symbols light up.

3

Cancel the last collected data.

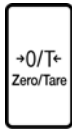

Press the [Zero/Tare] key.

The last collected data is cancelled and "CANCEL" is output.



You cannot cancel the second to last data. If you press the [Zero/Tare] key after cancelling data once, "8-Err" is displayed.

3-8-5 Clearing statistical operation results

You can clear all collected data. Note that this operation deletes ALL data. Print statistical operation results as needed before clearing data.

1

Set to the statistical operation display.



Press the [Function] key when the balance is displaying the weight.

2

Set the calculation item to "Sum total."

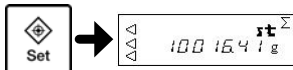

Press the [Set] key several times until the calculation item is set to "Sum total."

When the calculation item is "Number of data items," the "Σ" sign lights up.

3

Clear statistical operation results.

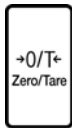

Press the [Zero/Tare] key.

The statistical operation results are cleared and "ALLCLR" is output.



When the "1.SET." setting is changed from "7" to another value or when the balance is turned off, statistical operation results are cleared too.

4 Adjusting the Balance

4-1 Adjusting (Calibrating) the Balance

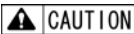

Calibrating a balance is also called span adjustment. Be sure to perform span adjustment to ensure highly accurate measurements.

Electronic balances are influenced by the acceleration of gravity. For this reason, you should adjust (calibrate) your balance every time you relocate it. You should also adjust (calibrate) it after a long period of use or if it does not indicate correct values.

	<p>To perform span adjustment (calibration), wait more than 5 hours after connecting the AC adapter. Use a weight for adjustment (calibration) that weighs 50% or more of the weighing capacity. To calibrate the balance more accurately, use a weight that is equivalent to the weighing capacity.</p> <p>For calibration of the internal weight, use a weight that has a mass equivalent to the weighing capacity.</p>
---	---

4-1-1 Span adjustment with internal weight

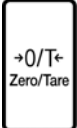
ANNOTATION This function is only available for the LFR type.

1	<p>Go to the function setting mode. (Refer to Section 2-6 "Basics of Function Settings.")</p>	<p>Press and hold the [Function] key until "Func" is displayed.</p>
2	<p>Select span adjustment with internal weight.</p> <div style="display: flex; align-items: center; margin-top: 10px;"> <div style="border: 1px solid black; padding: 5px; margin-right: 5px; text-align: center;">  Function </div> <div style="margin-right: 5px;">→</div> <div style="border: 1px solid black; padding: 5px; margin-right: 5px; text-align: center;">  →0/T← Zero/Tare </div> <div style="margin-right: 5px;">→</div> <div style="border: 1px solid black; padding: 5px; margin-right: 5px; text-align: center;"> 8. CR 1 </div> <div style="margin-right: 5px;">→</div> </div> <div style="margin-top: 10px;"> <div style="border: 1px solid black; padding: 5px; display: inline-block; text-align: center;">  Set </div> </div>	<p>Press the [Function] key several times to select "8.CA."</p> <p>Press the [Zero/Tare] key to select "8.CA. 1."</p> <p>Press the [Set] key to return to the weight display.</p>
3	<p>Start span adjustment.</p> <div style="margin-top: 10px;"> <div style="border: 1px solid black; padding: 5px; display: inline-block; text-align: center;">  Cal </div> <div style="margin-right: 5px;">→</div> <div style="border: 1px solid black; padding: 5px; display: inline-block; text-align: center;"> Aut. CAL </div> </div>	<p>Press the [Cal] key. "Aut. CAL" is displayed.</p>

4 Start automatic span adjustment using the internal weight.

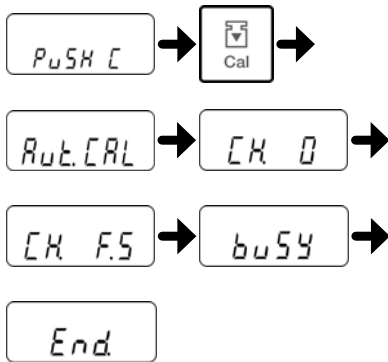

When "PuSH C" is displayed, press the [Cal] key.

The internal weight is activated and starts the span adjustment automatically.

The balance display changes to "Aut. CAL," "CH. 0," "CH. F.S.," "buSY," and then "End." When the span adjustment is completed, the balance returns to the weight display.

4-1-2 Span test with internal weight

ANNOTATION This function is only available for the LFR type.

1 Go to the function setting mode.
(Refer to Section 2-6 "Basics of Function Settings.")

Press and hold the [Function] key until "Func" is displayed.

2 Select span test with internal weight.

Press the [Function] key several times to select "8.CA."

Press the [Zero/Tare] key to select "8.CA. 2."

Press the [Set] key to return to the weight display.

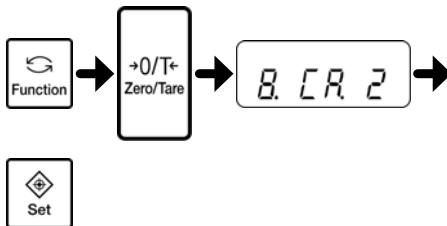

3 Start the span test.

Press the [Cal] key.

"t.Int" is displayed.

When "PuSH C" is displayed, press the [Cal] key.

The internal weight is activated and starts the span test automatically.

The balance display changes from "t.Int" to "t. 0," "t. F.S.," "dIFF.," and then "error display."

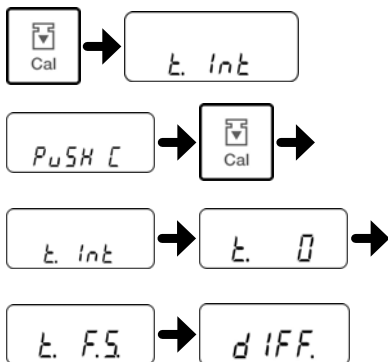

4 Return to the weight display.



Press the [Set] key.

The balance returns to the weight display.

4-1-3 Span adjustment with external weight

1 Go to the function setting mode.

(Refer to Section 2-6 “Basics of Function Settings.”)

Press and hold the [Function] key until “Func” is displayed.

2 Select the span adjustment with external weight.

Press the [Function] key several times to select “8.CA.”

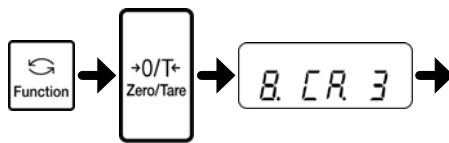

Press the [Zero/Tare] key to select “8.CA. 3.”

Press the [Set] key to return to the weight display.



3 Start span adjustment with external weight.

Press the [Cal] key.

“CAL EHT” is displayed.

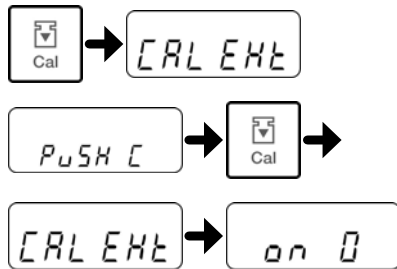

When “PuSH C” is displayed, press the [Cal] key.

The display changes from “CAL EHT” to “on 0” and then zero-point adjustment starts.

(If an instrumental error of weight is used, the entered instrumental error of weight is displayed for about two seconds.)

4 Place a weight on the weighing pan.

When zero-point adjustment is completed and “on F.S.” is displayed, place a weight on the weighing pan.

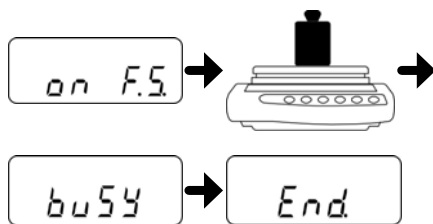

Adjustment will start.

The display changes to “buSY” and then “End.” When the span adjustment is completed, the balance returns to measurement mode.

4-1-4 Span test with external weight

1 Go to the function setting mode.
(Refer to Section 2-6 “Basics of Function Settings.”)

Press and hold the [Function] key until “Func” is displayed.

2 Go to the span test mode.

Press the [Function] key several times to select “8.CA.”

Press the [Zero/Tare] key to select “8.CA. 4.”

Press the [Set] key to return to the weight display.

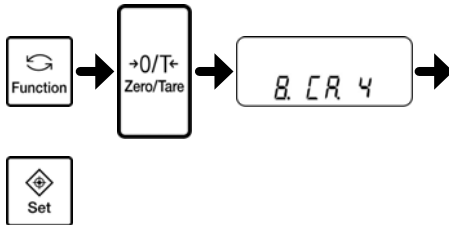

3 Start the span test with external weight.

Press the [Cal] key.

“t. EHT” is displayed.

When “PuSH C” is displayed, press the [Cal] key.

The display changes to “t. EHT” then “on 0” and then zero-point adjustment starts.

(If an instrumental error of weight is adopted, the entered instrumental error of weight is displayed for about two seconds.)

When zero-point adjustment is completed and “on F.S.” is displayed, place a weight on the weighing pan.

Adjustment will start.

The display changes to “dIFF.” and then “error display.”

4 Place a weight on the weighing pan.

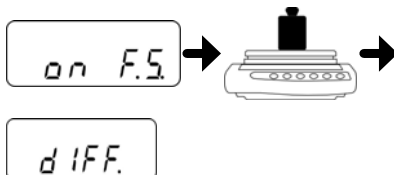

5 Return to the weight display.

Press the [Set] key.

The balance returns to the weight display.



4-2 Calibrating the Internal Weight

Use this function to calibrate the internal weight with a weight. You should calibrate the internal weight after the balance has been subjected to a strong impact, for example.

ANNOTATION This function is only available for the LFR type.

1 Go to Function 2 setting mode.

While pressing the [Zero/Tare] key, press and hold the [Function] key. After "Func2" is displayed, release the keys.

2 Select calibration of internal weight.

Press the [Function] key several times to select "3.r.CA."
 Press the [Zero/Tare] key to select "1."
 Press the [Function] key.
 The display changes to "rEF. CAL."

3 Start the calibration of the internal weight.

While pressing the [Zero/Tare] key, press the [Function] key, and release the keys simultaneously.

4 Start the zero-point adjustment.

"on 0" blinks on the display and zero-point adjustment is started.

5 Place a weight on the weighing pan.

When zero-point adjustment is completed and "on F.S." is displayed, place a weight on the weighing pan.
 When "on F.S." starts blinking on the display, span adjustment has started.

6

Unload the weight from the weighing pan.

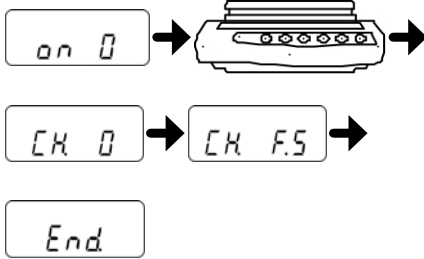

When span adjustment is completed and “on 0” is displayed, unload the weight from the weighing pan.

After the weight is unloaded, the balance automatically starts calibration of the internal weight.

The display changes to “CH. 0,” “CH. F.S.” and then “End.”

7

Finish the calibration of the internal weight.

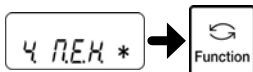

When “4.M.E.H.*” is displayed, press the [Function] key to return to measurement mode.

* For details on “4.M.E.H.*,” refer to Section 4-3 “Entering the instrumental error of a weight for use.”)

1. When the [Print] key is pressed during span adjustment or span test, “StOP” is displayed. Then the span adjustment or span test is discontinued and the balance returns to the weight display.

Reference

2. For span adjustment or a span test with external weight, use a weight that weighs 50% or more of the weighing capacity. To calibrate the balance more accurately, use a weight that is equivalent to the weighing capacity.

-
-
3. If there are any problems with results of span adjustment or span tests, the following messages are displayed:
- (1) "1-Err": This means that you have used a reference weight that weighs less than 50% of the weighing capacity during span adjustment with an external weight.
 - (2) "2-Err": This means that an error of over 1.0% was detected, or the balance has malfunctioned during span adjustment with an external weight.
 - (3) "3-Err": This means that you have adjusted the balance with a sample placed on the weighing pan during adjustment with the internal weight.
 - (4) "4-Err": This means that an error of over 1.0% was detected, or the balance has malfunctioned during adjustment using the internal weight.
 - (5) "A-Err": This means that the internal drive has malfunctioned during adjustment using the internal weight.

Reference

(When an error message is displayed, press any key to return to the measurement mode.)

* When any of these messages is displayed, calibration is not performed.

Check the weight and do this procedure over again.

4. If GLP compliant output is set to ON, the output is performed at the end of span adjustment/test. At this time, the display continues to show "output" for span adjustment or an error for span test. The balance may seem to have frozen during output, but this is normal. Wait until output is completed. (Refer to Section 6-1 "Output to Printers.")
-
-

4-3 Entering the Instrumental Error of a Weight for Use

To adjust (calibrate) the balance more accurately, enter the instrumental error of an external weight to be used for span adjustment or span tests. (Enter the instrumental error in mg.)

1

Go to Function 2 setting mode.

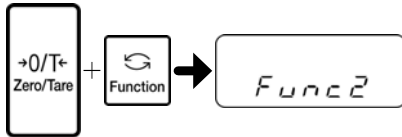

While pressing the [Zero/Tare] key, press and hold the [Function] key. After "Func2" is displayed, release the keys.

2

Select display of instrumental error.

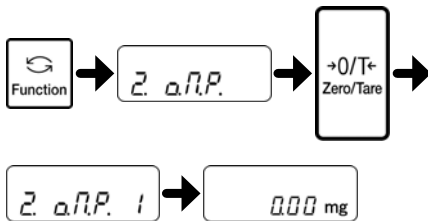

Press the [Function] key several times to select "2.o.M.P." Press the [Zero/Tare] key to select "1."

3

Start entering the instrumental error.

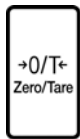

Press the [Zero/Tare] key. The leftmost digit will blink.

4

Enter a value.

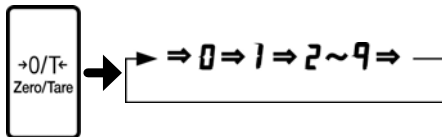

Press the [Zero/Tare] key to change the value in the blinking digit.

5

Move to the other digits to enter numbers.



Press the [Function] key to move the cursor to the left and the digit in the cursor position will then start blinking.

If the cursor is at the leftmost digit, it moves to the negative sign setting "M" and then returns to the rightmost digit.

Press the [Print] key to return to the state in step 2.

6

Save the instrumental error.

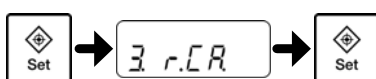

Press the [Set] key.

The display changes to "3.r.CA."

Press the [Set] key again to return to the measurement mode.

ANNOTATION

To use the entered instrumental error

To use the entered instrumental error, set Function 2 to "4.M.E.H. 1."

4-4 Se-CAL (full automatic calibration function)

Se-CAL function is composed of two functions. One is Advice CAL, which advises the user to perform calibration by showing blinking “CAL” in the display. “CAL” start blinking when a certain amount of time elapses since the previous calibration or when the temperature changes. Another is full automatic calibration function, which automatically perform calibration after 10 minutes have passed since “CAL” start blinking.

ANNOTATION The full automatic calibration function is only available for the LFR type.

- 1** Go to the function setting mode.
(Refer to Section 2-6 “Basics of Function Settings.”)

Press and hold the [Function] key until “Func” is displayed.
- 2** Select full automatic calibration.

Press the [Function] key several times to select “E.Ad.C.”

Press the [Zero/Tare] key to select “1” or “2.”

“E.Ad.C.0”: Both functions are inactive.
 “E.Ad.C.1”: Advice CAL function is active.
 “E.Ad.C.2”: Full automatic calibration function is active.

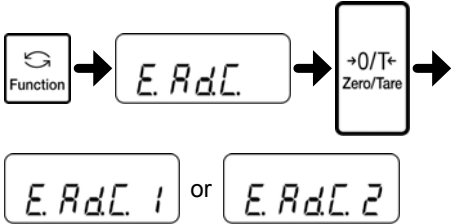
- 3** Return to the weight display.

Press the [Set] key.

The balance returns to the weight display.



Reference

- The full automatic calibration function is performed only when “8.CA.1” (span adjustment with internal weight) is selected.

4-5 Repeatability Measurement

Repeatability measurement is a function that takes ten span measurements by placing and removing weights and calculates the standard deviation of the measurement results. There are two methods for repeatability measurement: Automatic Repeatability Measurement (ARM) with internal weight or Semi-Automatic Repeatability Measurement (SARM) with external weight. You can conduct stable measurements by adjusting the response speed according to the measurement results.

4-5-1 Automatic Repeatability Measurement (ARM)

ANNOTATION This function is only available for the LFR type.

- 1** Go to the function setting mode.
(Refer to Section 2-6 "Basics of Function Settings.")

Press and hold the [Function] key until "Func" is displayed.
- 2** Set repeatability measurement to Automatic Repeatability Measurement (ARM).

Press the [Function] key several times to select "F.ArM."
Press the [Zero/Tare] key to select "1."

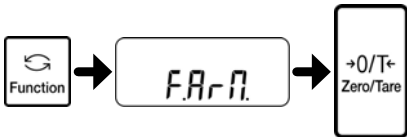
- 3** Return to the weight display.



Press the [Set] key.
The balance returns to the weight display.

- 4** Start the Automatic Repeatability Measurement (ARM).

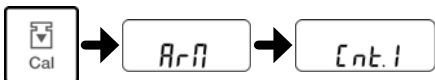
Press and hold the [Cal] key until "ArM" is displayed.
After a short time, the display changes to "Cnt.*" and the measurement is started.
As the number of span measurements increases, the number shown in "Cnt.*" increases to 1, 2, 3, and so on. When the number reaches "10," the measurements are completed and the standard deviation is displayed.



<Press and hold>

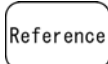

- 5** Return to the weight display.

Press any key.
The balance returns to the weight display.



• To discontinue the measurement, press the [Print] key.

4-5-2 Semi-Automatic Repeatability Measurement (SARM)

1 Go to the function setting mode.
(Refer to Section 2-6 "Basics of Function Settings.")

Press and hold the [Function] key until "Func" is displayed.

2 Set repeatability measurement to Semi-Automatic Repeatability Measurement (SARM).

Press the [Function] key several times to select "F.ArM."
Press the [Zero/Tare] key to select "2."

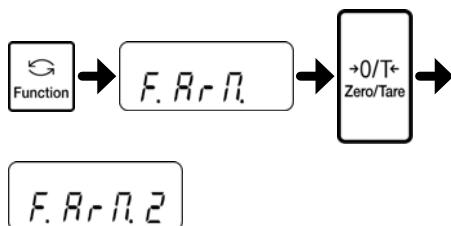

3 Return to the weight display.

Press the [Set] key.

The balance returns to the weight display.



4 Start the Semi-Automatic Repeatability Measurement (SARM).

Press and hold the [Cal] key until "SArM" is displayed.

After a short time, the display changes to "Cnt.1" and the measurement is started.

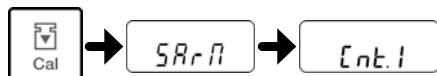

<Press and hold>

5 Measure the zero point.

The display changes to "on 0" and the zero-point measurement is started.

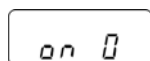

6 Place a weight on the weighing pan.

When the zero-point measurement is completed and "on F.S." is displayed, place a weight on the weighing pan.

The span measurement is started.

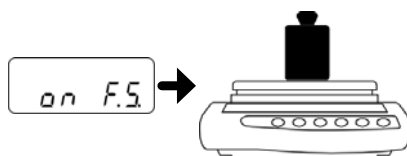

7

Repeat steps 5 and 6.

Display the standard deviation.



Standard deviation

8

Return to the weight display.

Press any key.

The balance returns to the weight display.

-
- To discontinue the measurement, press the [Print] key.
 - The standard deviation displayed after the Automatic Repeatability Measurement (ARM)

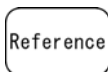



is the result of measurement using the internal weight equivalent to the weighing capacity. To obtain a result of measurements in a state similar to how you use the balance, use an appropriate weight and conduct the Semi-Automatic Repeatability Measurement (SARM).

4-6 Easy RES Function (single-touch response time change)

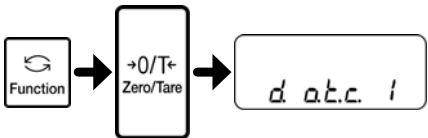

Easy RES function enables the user to change the response speed very easily. You can change response speed just by pressing [Set] key.

By changing the response speed according to the degree of vibration in the place where the balance is installed, you can reduce the display fluctuation and the time spent waiting for the display to stabilize.

- 1 Go to the function setting mode.
(Refer to Section 2-6 “Basics of Function Settings.”)
Press and hold the [Function] key until “Func” is displayed.
- 2 Set the single-touch response speed.
Press the [Function] key several times to select “d.o.t.c.”
Press the [Zero/Tare] key to select “1.”

- 3 Save the setting.
Press the [Set] key.
The balance returns to the weight display.

When the [Set] key is pressed once, the current setting is displayed. Each time the [Set] key is pressed, the response speed changes in three steps: “NORMAL,” “SLOW,” and “FAST” in this order. After the setting is completed, the balance returns to measurement mode automatically.

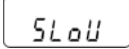
This function is related to Function 1 “5A.rE.” and “5C.Fr.” settings.

[Set] key	Meaning	Description	Related Function 1 setting	
			“5A.rE.”	“5C.Fr.”
	FAST	Fast response Easily affected by vibration	0	1
	NORMAL	Halfway between FAST and SLOW	2	2
	SLOW	Slow response Hardly affected by vibration	4	4

Reference

-
- Setting "5A.rE." to "1" results in the fastest response, which is suitable for use in a place hardly affected by vibration. Setting "5A.rE." to a larger number up to "7" results in lower response, which is suitable for use in a place significantly affected by vibration.
 - Setting "5C.Fr." to "0" results in the fastest response, which is suitable for use in a place hardly affected by vibration. Setting "5C.Fr." to a larger number up to "4" results in lower response, which is suitable for use in a place significantly affected by vibration.
-



This function is not available when the addition function or the gravimeter mode is used.

5 Setting the Functions

5-1 Select and Switch of Weighing Units

You can set two units (unit A and unit b) and switch between the units.

Reference Unit b can only be used in simple weight measurement mode. Unit A can be used in all measurement modes.

- 1** Go to the function setting mode.
(Refer to Section 2-6 “Basics of Function Settings.”)

Press and hold the [Function] key until “Func” is displayed.
- 2** Set unit A.

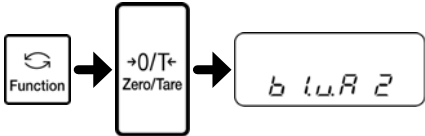

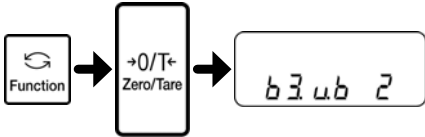

Press the [Function] key several times to select “b1.u.A.”
Press the [Zero/Tare] key to select a unit from the following numbers:
1:mg/2:g/4:ct (carat)/d:mom (momme)
When only setting unit A, press the [Set] key in this step to save the setting.
- 3** Set unit b.



Press the [Function] key several times to select “b3.u.b”
Press the [Zero/Tare] key to select a unit from the following numbers:
0: Unit b is not used/1:mg/2:g/4:ct (carat)/d:mom (momme)

Reference
Unit b can only be used in simple weight measurement mode.
Press the [Set] key.
The balance returns to the weight display.
- 4** Save the setting.

- 5** Switch between unit A and unit b.



Press the [Function] key during measurement.
This switches between unit A*, unit A (gross), and unit b*.
(* “Net” lights up during tare range setting.)

5-2 Readability Setting

Use this function to set the readability. The larger the readability becomes, the less the balance is affected by external influences. In addition, it takes less time for the balance reading to stabilize.

Each unit has a different readability.

ANNOTATION The readability setting is available for the single-range type only.

- 1** Go to the function setting mode.
(Refer to Section 2-6 “Basics of Function Settings.”)

Press and hold the [Function] key until “Func” is displayed.
- 2** Select the readability.

Press the [Function] key several times to select “b2.d.A.”

Press the [Zero/Tare] key to select from 1 through 5.

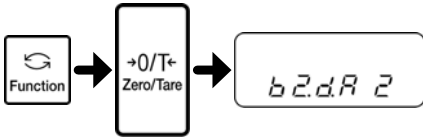
- 3** Save the setting.

Press the [Set] key.

The balance returns to the weight display.



Reference

To set the readability of unit b, select “b4.d.b” in step 2.

You can also set the same unit for unit A and unit b, and set different minimum indications, so that unit A and unit b can be used to switch the readability.

■ List of readability settings

Set value	LF(R)-124 / -224				LF-135R			
	mg	g	ct	mom	mg	g	ct	mom
1	0.1	0.0001	0.001	0.0001	0.01	0.00001	0.0001	0.00001
2	0.2	0.0002	0.002	0.0002	0.2	0.00002	0.0002	0.00002
3	0.5	0.0005	0.005	0.0005	0.05	0.00005	0.0005	0.00005
4	1	0.001	0.01	0.001	0.1	0.0001	0.001	0.0001
5	2	0.002	0.02	0.002	0.2	0.0002	0.002	0.0002

5-3 Automatic Switching of Scale Intervals

With this function, the readability of the balance automatically switches between 0.00001 g for gross readout equal to or less than 92.00000 g and 0.0001 g for gross readout over 92.00000 g.

ANNOTATION Automatic switching between two scale intervals is only available for the LF225DR.
You can use it when the balance is displaying the weight.

1 Go to the function setting mode. (Refer to Section 2-6 “Basics of Function Settings.”) Press and hold the [Function] key until “Func” is displayed.

2 Set automatic switching of scale intervals to ON. Press the [Function] key several times to select “C.d.r.”
Press the [Zero/Tare] key to select “1.”

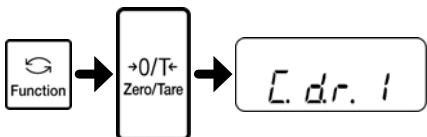

3 Return to the weight display. Press the [Set] key.
The balance returns to the weight display.



Reference

When any unit other than “g” is selected, the two scale intervals are switched at a weight equivalent to 92.00000 g.

5-4 Turning ON/OFF the Automatic Switching of Scale Intervals with a Single Touch

This function allows you to turn on or off the automatic switch between two scale intervals just by pressing the [Set] key.

ANNOTATION

Automatic switching between two scale intervals is only available for the LF225DR. You cannot use it when using the addition function, the gravimeter mode or the statistical operation function.

You can use it when the balance is displaying the weight.

1

Go to the function setting mode.

Press and hold the [Function] key until "Func" is displayed.

(Refer to Section 2-6 "Basics of Function Settings.")

2

Set the function that turns on or off the automatic switching of scale intervals.

Press the [Function] key several times to select "d.o.t.c."
Press the [Zero/Tare] key to select "2."



3

Save the setting.

Press the [Set] key.

The balance returns to the weight display.



Reference

- This function is related to Function 1 "C.d.r." setting, which will be changed according to this setting.

5-5 Saving the Container (Tare) Weight

Use this function to set a tare range when the balance is turned on using the latest saved tare weight. Use this function when you turn the balance on or off with a sample and tare on the pan.



Leaving the balance with a substance and tare on it for a long period of time may result in a larger error in weighing. You should set the tare range regularly.

- 1** Go to the function setting mode.
(Refer to Section 2-6 “Basics of Function Settings.”)

Press and hold the [Function] key until “Func” is displayed.
- 2** Set the tare memory.

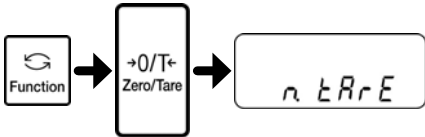

Press the [Function] key several times to select “n.tArE.”
Press the [Zero/Tare] key to select “1.”
- 3** Save the setting.



Press the [Set] key.
The balance returns to the weight display.
- 4** Save the tare weight.

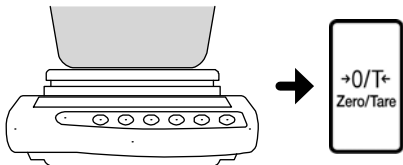

Place the container (tare) the weight of which you want to save and then measure the tare.
The saved tare weight is updated every time a tare range is set.

5-6 Power Setting

5-6-1 Automatic backlight-off function

This function automatically turns off the backlight if the balance is left untouched in measurement mode for about 3 minutes.

- 1** Go to the function setting mode.
(Refer to Section 2-6 “Basics of Function Settings.”)

Press and hold the [Function] key until “Func” is displayed.
- 2** Set the automatic backlight-off function.

Press the [Function] key several times to select “A.A.b.”
Press the [Zero/Tare] key to select “1.”

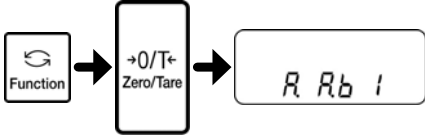

```

graph LR
    A[Function] --> B["+0/T+  
Zero/Tare"]
    B --> C["R Rb 1"]
  
```
- 3** Save the setting.

Press the [Set] key.
The balance returns to the weight display.



The automatic backlight-off function does not work under the following conditions:

Reference

- Function settings are displayed.
- An object is placed on the weighing pan and the display is not stable.

Placing an object on the weighing pan or pressing a key turns the backlight on again.

5-7 Date and Time Setting

5-7-1 Time setting

Use this function to set the time of the 24 hour clock (hours:minutes:seconds).

1 Open the time view.

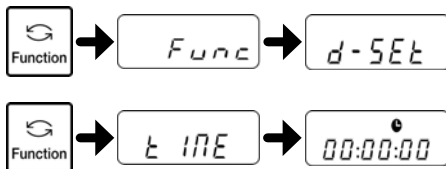

Press and hold the [Function] key for several seconds.

After "Func" changes to "d-SEt" in the display, release the key.

Press the [Function] key once. After "tImE" is displayed, the time is displayed.

2 Adjust the time.

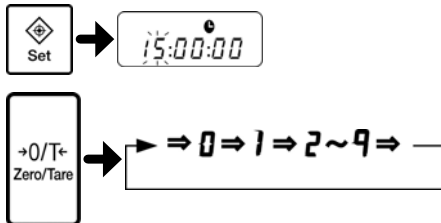

Press the [Set] key. The value in the location of the cursor can be changed.

Change the value in the location of the cursor using the [Zero/Tare] key.

Press the [Function] key to move the cursor to the right. If the cursor is at the rightmost digit, it returns to the leftmost digit.

Pressing the [Print] key while making the setting returns to the time that was set before you started making changes.

3 Save the time.



Press the [Set] key.

The display changes to the date view. If the date does not need to be changed, leave the setting screen using the [Function] key.



5-7-2 Date setting

The last two digits of the western calendar year are displayed for the year. The order in which the year, month, and day appear can be changed using Function 1.

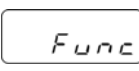
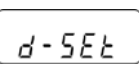
- 1** Open the date view.

→

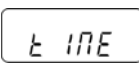
→

Press and hold the [Function] key for several seconds. After "Func" changes to "d-SEt" in the display, release the key.

→

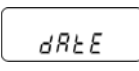
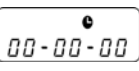
→



Press the [Function] key to display the time, and then press the [Function] key again.

→

→

After "dAtE" is displayed, the display automatically changes to the date view.
- 2** Adjust the date.

Follow step 2 in "Time Setting" to change the date.
- 3** Save the date.

Press the [Set] key.





5-8 Date View

Use this function to set the order in which the year, month, and day are displayed or output to printers and other devices to indicate the date stored in the balance.

- 1** Go to the function setting mode.
(Refer to Section 2-6 "Basics of Function Settings.")

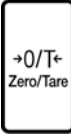
Press and hold the [Function] key until "Func" is displayed.
- 2** Set the order in which the year, month and day are displayed.

→

→

Press the [Function] key several times to select "H.dAtE."
Press the [Zero/Tare] key to select "H.dAtE 1 to 3."

"H.dAtE 1": Year-Month-Day
"H.dAtE 2": Month-Day-Year
"H.dAtE 3": Day-Month-Year
- 3** Save the order.

Press the [Set] key.



5-9 Time Output

Use this function to output the current time along with measurement data. Set the time before using this function.

1 Go to the function setting mode.
 (Refer to Section 2-6 "Basics of Function Settings.")

Press and hold the [Function] key until "Func" is displayed.

2 Set the time output function.

Press the [Function] key several times to select "J.t.o."

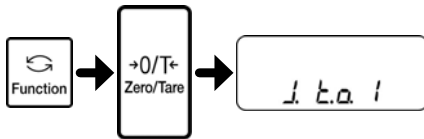

Press the [Zero/Tare] key to select "J.t.o. 1."

3 Save the setting of time output function.

Press the [Set] key.



5-10 Interval Output Function

Use this function to output data at specified intervals. Set the interval time in “hour:minute:second” form.

Reference

• You can output time with measurement data. To output time, refer to Section 5.9 “Time Output.”

- 1** Go to the function setting mode. (Refer to Section 2-6 “Basics of Function Settings.”)

Press and hold the [Function] key until “Func” is displayed.
- 2** Set the output control to “Output once after a set interval elapses” or “Output once in a stable state after a set interval elapses.”

Press the [Function] key several times to select “71.o.c.” Press the [Zero/Tare] key to select “A” or “b” and then press the [Set] key.
 71.o.c.A = Output once after a set interval elapses
 71.o.c.b = Output once in a stable state after a set interval elapses

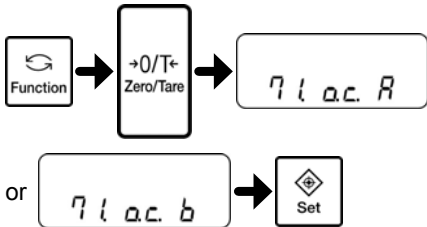
- 3** Bring up the interval function.

Press and hold the [Set] key until “Int.VAL” is displayed. The interval time is displayed and the cursor is located at the leftmost digit.



<Press and hold>
- 4** Set the interval time.

Change the value at the location of the cursor using the [Zero/Tare] key.

Press the [Function] key to move the cursor to the right. If the cursor is at the rightmost digit, it returns to the leftmost digit.

Pressing the [Print] key while making the setting returns to the weight display without saving the setting.

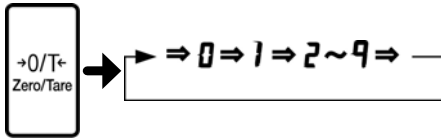
- 5** Save the setting and return to the weight display.

Press the [Set] key. The balance returns to the weight display.



6

Start interval output.



Press the [Print] key.

After "StArt" is displayed, interval output starts.

7

End interval output.

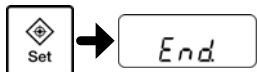

Press the [Print] key.

After "End." is displayed, the balance returns to the weight display.



- Output stops in the function setting mode.
- When "6-Err" is displayed, it indicates that the interval time is set to zero. Set the interval time again (Press any key to delete the error display.)

5-11 ID No. Setting

Results of successfully completed span adjustments and span tests can be printed by ISO/GLP/GMP compliant devices. Set the ID number printed with the results.

In situations such as when the same model is used, you can assign numbers that allow you to easily manage them.

You can use up to six digits in an ID number. The characters that you can use are as follows:
Spaces, 0 to 9, A to F, - (minus)

- 1** Go to Function 2 setting mode.

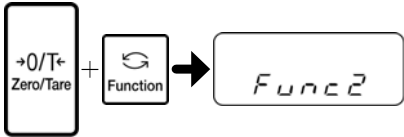

Press the [Function] key while pressing the [Zero/Tare] key. Release the keys when “Func2” is displayed.

Function 2 setting mode is set and “1. Id 0” is displayed.
- 2** Set the ID number.

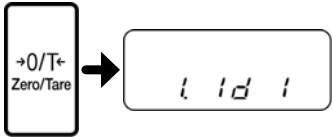

Press the [Zero/Tare] key to select “1.”
- 3** Go to the ID number setting mode.



Press the [Function] key.
- 4** Enter the ID number.

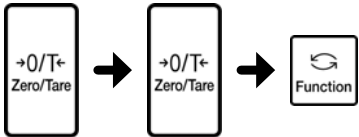

Enter the ID number with the following steps:

 - (1) Press the [Zero/Tare] key. The leftmost digit will blink.
 - (2) Press the [Zero/Tare] key to select a character. Pressing the key toggles between a space, 0 to 9, A to F, and - (minus).
 - (3) Pressing the [Function] key causes the next digit to blink.

Set the ID number by repeating steps (2) and (3).

(When ID number is being displayed or set, “•” and “▲” appear in the upper left of the display.)

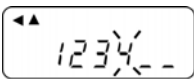
- 5** Save the ID number.

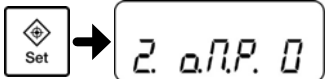

Press the [Set] key.

The display changes to “2.o.M.P.0.”

Press the [Set] key again to return to the weight display.

5-12 Improving the Stability of the Balance

When the balance is stable, “O” (stability indicator) appears in the upper left of the display. When displayed values flicker or the stability indicator blinks, this indicates that the balance is being affected by wind or vibration. In these situations, a setting change can improve stability. The greater the values set in the “4A.S.h (stability judgment width,” “4b.S.C. (number of stability judgments),” “5A.rE. (response speed),” “5C.Fr. (signal processing),” and “b2.d.A/b4.d.b (minimum readability setting)” function settings, the better the stability will be.

Relationship between each function setting and the effect of wind/vibration

Effect of wind/vibration	4A.S.h (stability judgment width)	4b.S.C. (number of stability judgments)	5A.rE. (response speed)	5C.F.r. (signal processing)
Small Big	1	1	0	1
	2	2	1	2
	3	3	2	3
	4	4	3	4
	5	5	4	
	6	6	5	
	7		6	
	8		7	

Method 1) Decrease the weight change speed to reduce the effects of wind and vibration.

First, incrementally set “5A.rE. (response speed)” to larger values up to 4. If this does not improve the stability of the balance, incrementally set “5C.Fr. (signal processing)” to larger values.

Method 2) Change the stability indicator lighting criteria to prevent the stability indicator from blinking.

This method does not affect the flickering of displayed values, but affects when the stability indicator lights up.



- Setting larger values reduces blinking and causes the stability indicator to light up faster. Set larger values for “4A.S.h (stability judgment width)” and “4b.S.C. (number of stability judgments)” in this order.

- Setting smaller values reduces blinking and causes the stability indicator to take longer to light up.

Set smaller values at “4b.S.C. (number of stability judgments)” and “4A.S.h (stability judgment width)” in this order.

Method 3) Set the minimum readability to a larger value to improve both flicker of displayed values and blinking of the stability indicator. (This method cannot be used for the LF225DR.)

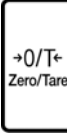
Set a larger value for “b2.d.A/b4.d.b (minimum readability setting).”

- | | | |
|---|--|--|
| 1 | <p>Go to the function setting mode.
(Refer to Section 2-6 “Basics of Function Settings.”)</p> | <p>Press and hold the [Function] key until “Func” is displayed.</p> |
| 2 | <p>Set each function.</p> <div style="border: 1px solid black; padding: 5px; width: fit-content; margin: 10px auto;">  </div> | <p>Press the [Function] key several times to select the function to set. (See the above table).</p> <p>4A.S.h.= Stability judgment width
 4b.S.C.= Number of stability judgments
 5A.rE.= Response speed
 5C.Fr. = Signal processing
 b2.d.A= Readability setting (A)
 b4.d.b= Readability setting (B)</p> |
| 3 | <p>Select a setting.</p> <div style="border: 1px solid black; padding: 5px; width: fit-content; margin: 10px auto;">  </div> | <p>Press the [Zero/Tare] key to select a set value for each function (see the above table).</p> |
| 4 | <p>Save the setting.</p> <div style="border: 1px solid black; padding: 5px; width: fit-content; margin: 10px auto;">  </div> | <p>Press the [Set] key.
The balance returns to the weight display.</p> |

5-13 α -Check(self-diagnosis function)

α -check function gives the users menu of self-diagnosis of the balance. It is composed of five test items, display test, key test, motor test, check of calibration history, and repeatability test.

5-13-1 Display test

Use the display test to check whether all display segments are working properly.

- 1** Go to the function 2 setting mode.

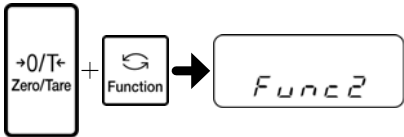

While pressing the [Zero/Tare] key, press the [Function] key. After "Func2" is displayed, release the keys.
- 2** Select α -check function.

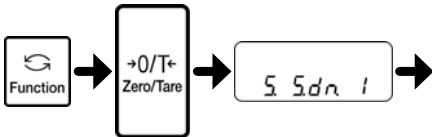

Press the [Function] key several times to select "5.S.dn." Press the [Zero/Tare] key to select "1," and then press the [Function] key. "51.d.t." is displayed.

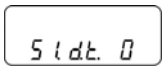
- 3** Start the test.

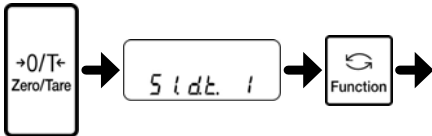

Select "51.d.t." Press the [Zero/Tare] key to select "1" and then press the [Function] key. "dSP.tEst." is displayed.

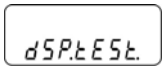
- 4** Check the display.

Press the [Function] key several times.

Pressing the [Function] key toggles the display between "dSP.tEst.," all ON and all OFF.
- 5** Print the test result.

Press and hold the [Print] key.

The test result is output.
- 6** End the test.

Press the [Set] key to end the test. Press the [Set] key again to return to the weight display.

CAUTION The test result can only be output after all ON and all OFF are checked.

5-13-2 Key test

Use the key test to check whether the keys are working properly.

- 1** Go to the function 2 setting mode.

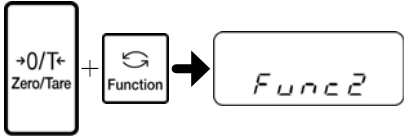

While pressing the [Zero/Tare] key, press the [Function] key. After "Func2" is displayed, release the keys.
- 2** Select α -check function.

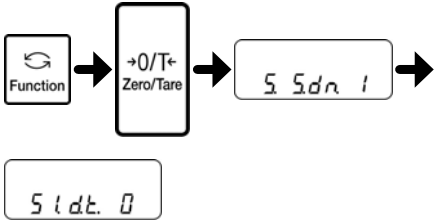

Press the [Function] key several times to select "5.S.dn." Press the [Zero/Tare] key to select "1," and then press the [Function] key. "51.d.t." is displayed.
- 3** Start the test.

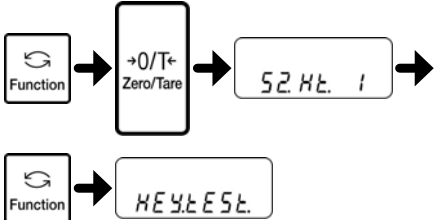

Press the [Function] key several times to select "52.K.t." Press the [Zero/Tare] key to select "1" and then press the [Function] key. "KEy.tEst." is displayed.
- 4** Check the keys.

Press the keys several times.

Pressing each key should bring up the following display:

[Zero/Tare] key (left)	"tArE1"
[Zero/Tare] key (right)	"tArE2"
[Function] key	"Function"
[Set] key	"Set"
[Cal] key	"CAL"
[Print] key	"Print"
- 5** Print the test result.

Press and hold the [Print] key.

The test result is output.
- 6** End the test.

Press the [Set] key twice to end the test. Press the [Set] key again to return to the weight display.

CAUTION The test result can only be output after all the keys are checked.

5-13-3 Motor test

Use the motor test to check whether the internal weight is working properly.

ANNOTATION This function is only available for the LFR type.

- 1** Go to the function 2 setting mode.

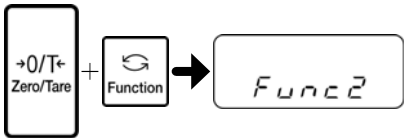

While pressing the [Zero/Tare] key, press the [Function] key. After "Func2" is displayed, release the keys.
- 2** Select α -check function.

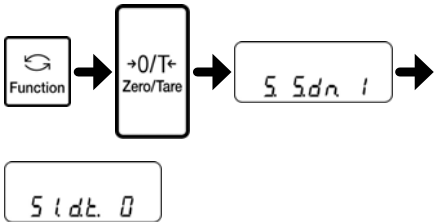

Press the [Function] key several times to select "5.S.dn."
Press the [Zero/Tare] key to select "1," and then press the [Function] key.
"51.d.t." is displayed.
- 3** Start the test.

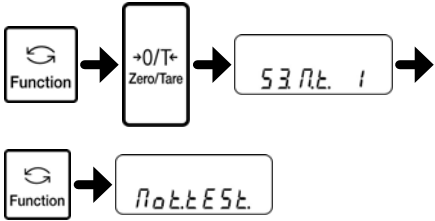

Press the [Function] key several times to select "53.M.t."
Press the [Zero/Tare] key to select "1" and then press the [Function] key.
"Mot.tEst." is displayed.
- 4** Activate the internal weight.

Press the [Function] key.
The internal weight is activated.
- 5** Print the test result.

Press and hold the [Print] key.
The test result is output.
- 6** End the test.

Press the [Set] key to end the test. Press the [Set] key again to return to the weight display.

CAUTION The test result can only be output after the internal weight is activated.

5-13-4 Span adjustment history

Use this function to display and print the history of span adjustments. The balance saves the history data of the last ten span adjustments with the history numbers “HIS.1” (newest) to “HIS.10” (oldest).

ANNOTATION This function does not work when no history data is saved.
History data cannot be deleted once it is saved.

- 1** Go to the function 2 setting mode.

While pressing the [Zero/Tare] key, press the [Function] key. After “Func2” is displayed, release the keys.

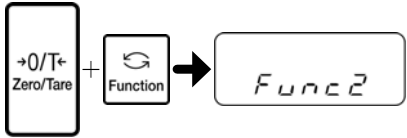
- 2** Select α -check function.

Press the [Function] key several times to select “5.S.dn.” Press the [Zero/Tare] key to select “1” and then press the [Function] key. “51.d.t.” is displayed.

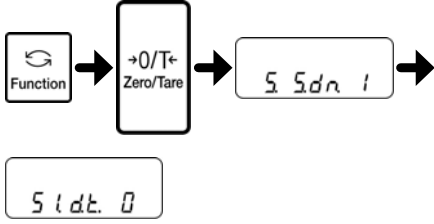
- 3** Start the test.

Press the [Function] key several times to select “54.Sc.t.” Press the [Zero/Tare] key to select “1” and then press the [Function] key. “CAL.HiSt.” is displayed.

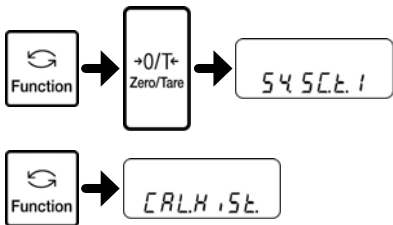
- 4** Display details of history data.

When the history number is displayed, press the [Zero/Tare] key several times.

Pressing the [Zero/Tare] key cyclically shows “history number,” “type of adjustment,” “date,” “time,” “temperature” and “error display.”
- 5** Display the next history data.

Press the [Function] key. The next history data is displayed.
- 6** Repeat steps 4 and 5.

Repeat steps 4 and 5 to view the history.
- 7** Print the test result.

Press and hold the [Print] key. The test result is output.
- 8** End the test.

Press the [Set] key to end the test. Press the [Set] key again to return to the weight display.

5-13-5 Automatic Repeatability Measurement (ARM)

You can conduct an Automatic Repeatability Measurement (ARM) (Section 4-5-1) by using α -check function.

ANNOTATION This function is only available for the LFR type.

- 1

Go to the function 2 setting mode.

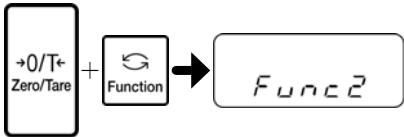

While pressing the [Zero/Tare] key, press the [Function] key. After "Func2" is displayed, release the keys.
- 2

Select α -check function.

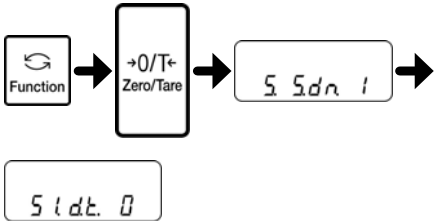

Press the [Function] key several times to select "5.S.dn."
Press the [Zero/Tare] key to select "1" and then press the [Function] key.
"51.d.t." is displayed.
- 3

Start the Automatic Repeatability Measurement (ARM).

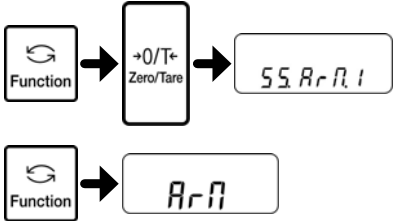

Press the [Function] key several times to select "55.ArM."
Press the [Zero/Tare] key to select "1" and then press the [Function] key.
"ArM" is displayed and the Automatic Repeatability Measurement (ARM) is started.

Reference For details on how to use the Automatic Repeatability Measurement (ARM), refer to Section 4-5-1 "Automatic Repeatability Measurement (ARM)."

5-13-6 Semi-Automatic Repeatability Measurement (SARM)

You can conduct an Automatic Repeatability Measurement (ARM) (Section 4-5-2) by using α -check function.

- 1** Go to the function 2 setting mode.

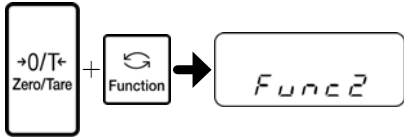

While pressing the [Zero/Tare] key, press the [Function] key. After "Func2" is displayed, release the keys.

- 2** Select α -check function.

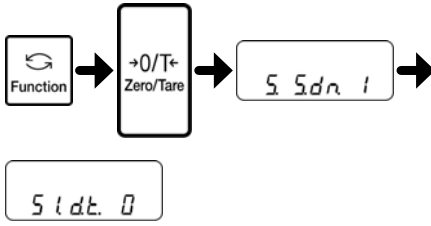

Press the [Function] key several times to select "5.S.dn."
Press the [Zero/Tare] key to select "1" and then press the [Function] key.
"51.d.t." is displayed.

- 3** Start the Semi-Automatic Repeatability Measurement (SARM).

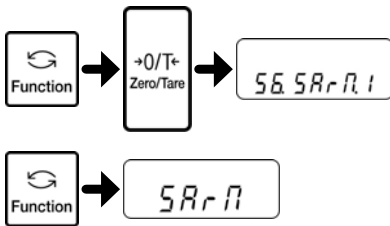

Press the [Function] key several times to select "56.SArM."
Press the [Zero/Tare] key to select "1" and then press the [Function] key.
"SArM" is displayed and the Semi-Automatic Repeatability Measurement (SARM) is started.

Reference

For details on how to use the Semi-Automatic Repeatability Measurement (SARM), refer to Section 4-5-2 "Semi-Automatic Repeatability Measurement (SARM)."

6 Input/Output to/from External Devices

6-1 Output to Printers

By connecting a printer to the balance, span adjustment results, span test results, and measurement results can be printed in an ISO/GLP/GMP compliant format.

6-1-1 Connecting a printer



Connect the RS-232C connector of the balance to a printer using the D-SUB9P cable. You can connect the balance to SHINKO DENSHI CSP-160 II printer or standard printer from printer manufacturers.

The following setting is required for the printer. Set it by referring to the operation manual of the printer.

- Set the printing function (printing control) to “balance control.”
- Match the baud rate and other communication settings to the settings of the balance.

CAUTION Set the date and time of the printer before printing.

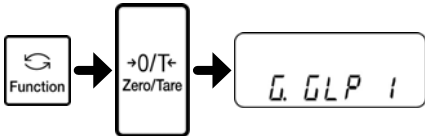
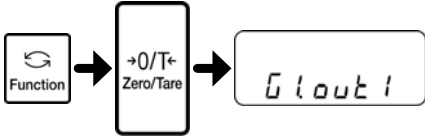
6-1-2 Printing span adjustment and span test results

1	Go to the function setting mode. (Refer to Section 2-6 “Basics of Function Settings.”)	Press and hold the [Function] key until “Func” is displayed.
2		Press the [Function] key several times to select “G.GLP.” Select “1” by pressing the [Zero/Tare] key.
3		Press the [Function] key several times to select “G1.out.” Select “1” by pressing the [Zero/Tare] key.
4	Save the setting. 	Press the [Set] key. The balance returns to the weight display.

5 Perform the span adjustment or span test.

After the span adjustment or span test is successfully completed, the printer executes the print job.

While the data is being printed, the balance may seem to be frozen, but wait until printing is completed. No printing is executed if the span adjustment or test is not successfully completed.



Do not press any keys on the printer during printing.

6-1-3 Printing measurement results

1 Go to the function setting mode.

(Refer to Section 2-6 "Basics of Function Settings.")

Press and hold the [Function] key until "Func" is displayed.

2

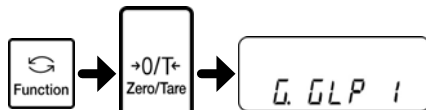

Press the [Function] key several times to select "G.GLP." Select "1" by pressing the [Zero/Tare] key.

3



Press the [Function] key several times to select "G2.od." Select "1" by pressing the [Zero/Tare] key.

4

Save the setting.



Press the [Set] key.

The balance returns to the weight display.

5

Print measurement results.

- Pressing and holding the [Print] key prints the header.
- Pressing the [Print] key at any time during measurements prints the result data.
- After the measurement is completed, press and hold the [Print] key to print the footer.



Do not press any keys on the printer during printing.

6-2 Connection of interface and the external equipment

The balance communicates with external devices such as a PC via the RS-232C interface.

The RS-232C interfaces equipped on the balance are a type-B USB and a D-SUB9P. Connection with external devices is established with the following specifications:

 CAUTION	Disconnect the AC adapter of the balance before connecting external devices.
--	--

6-2-1 Connector pin numbers and functions of the D-SUB9P

The D-SUB9P connector equipped on the balance has the following pin alignment:

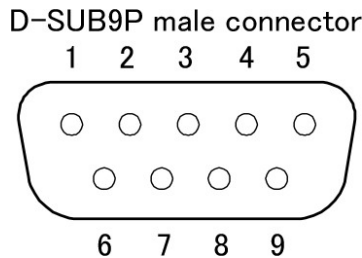

Pin number	Signal name	Input/Output	Function & Remarks
1	-	-	-
2	RXD	Input	Receiving data
3	TXD	Output	Transmitting data
4	DTR	Output	HIGH (When the balance is powered ON)
5	GND	-	Signal ground
6	-	-	-
7	-	-	-
8	-	-	-
9	EXT.TARE	Input	External tare range setting

Reference

You can set a tare range or adjust the zero-point from an external device by connecting a contact or a transistor switch between the pin for externally setting a tare range (Pin 9) and the signal ground pin (Pin 5). When doing so, allow at least 400 ms for connection (ON) time (Maximum voltage when the balance is turned OFF: 15 V, sink current when it is turned ON: 20 mA).

6-2-2 Examples of connection with a PC

Use the following examples as a guide to connect the balance to external devices using a cable.

- Examples of connection with a PC/AT compatible machine

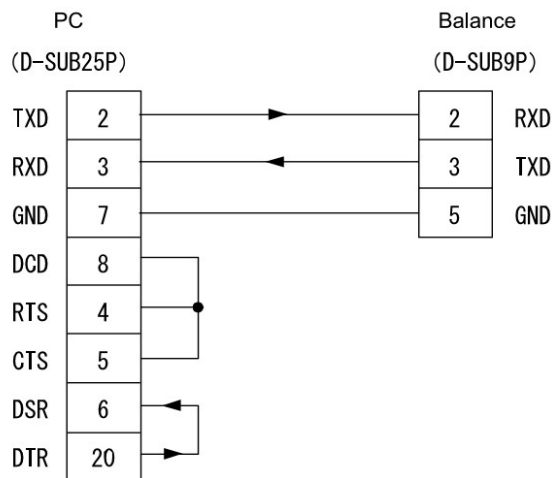
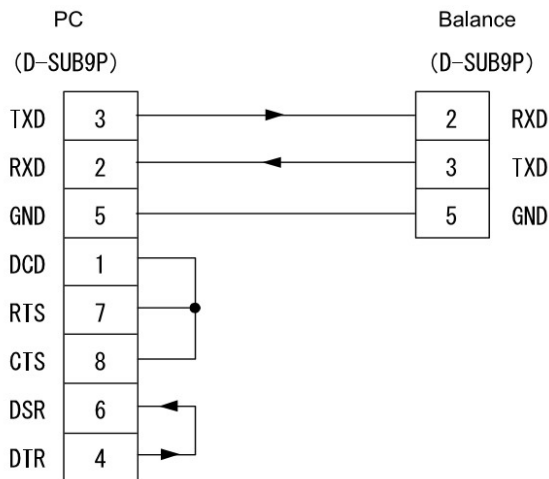

6-2-3 Connecting a type-B USB connector to a PC

- 1 Download the driver suitable for the OS installed on your PC from the following URL:<http://www.ftdichip.com/Drivers/VCP.htm>
- 2 Connect the AC adapter to the balance and turn the balance on.
- 3 Connect the balance to the PC using a USB cable. At this time, the USB adapter is detected as a new device. Install the driver.
- 4 After the driver is properly installed, check the port to which the balance is connected by using Device Manager, for example.
- 5 Set the application connection port to be used, and check that communication has been established.

If communication is not established properly, check the communication settings of both the balance and the application, and check whether communication has been established.

 CAUTION	<ul style="list-style-type: none"> • When the balance is connected to a PC via USB, the USB operates as a Virtual COM port inside the PC. Be sure to check which COM port the USB is connected to.
--	---

6-2-4 Interface specifications

Transmission system	Serial transmission, Start-stop synchronization
Transmission rate	1200/2400/4800/9600/19200 bps
Transmission codes	ASCII codes (8/7 bits)
Signal level	Compliant with EIA RS-232C HIGH level (data logic 0): +5 to +15 V LOW level (data logic 1): -5 to -15 V
Bit configuration	Start bit: One bit Data bits: 8/7 bits ("7 bits" can only be specified for the extended 7/8-digit numeric format.) Parity bits: 0/1 bit Stop bits: 2/1 bit ("1 bit" can only be specified for the extended 7/8-digit numeric format.)
Parity bit	None/Odd/Even

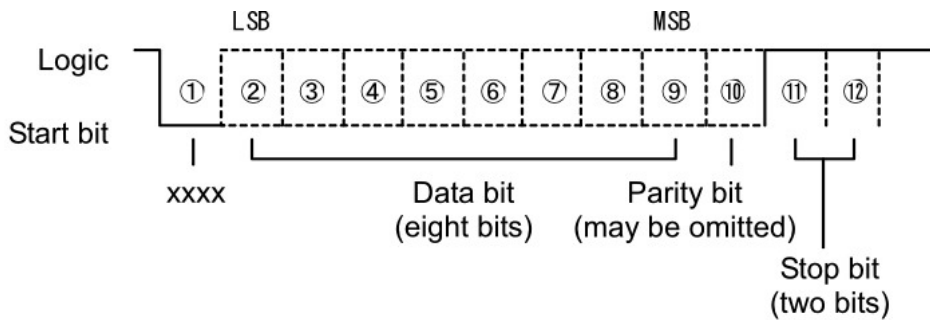

6-3 Communication Data and Commands

The RS-232C interface exchanges data with external devices as follows:

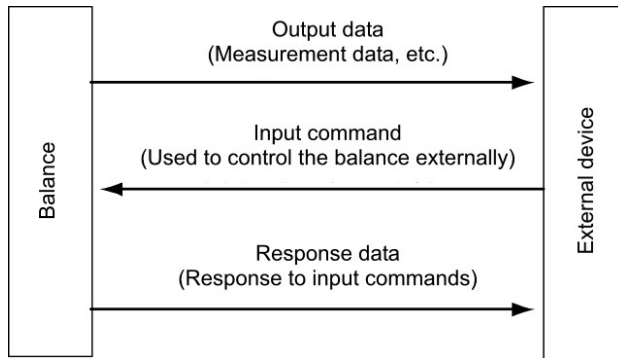

6-4 Output Data

The five formats “6-digit numeric,” “7-digit numeric,” “extended 7-digit numeric,” “special format 1” and “special format 2” are available. Select a format by performing the following steps:

- 1 Go to the function setting mode. (Refer to Section 2-6 “Basics of Function Settings.”) Press and hold the [Function] key until “Func” is displayed.

- 2 Press the [Function] key several times to select “7.1.F.” Press the [Zero/Tare] key to select a format.
 - 2 = 7-digit numeric format
 - 3 = Extended 7-digit numeric format
 - 41= Special format 1
 - 42= Special format 2
 - 5 = 8-digit numeric format
 - 6 = Extended 8-digit numeric format

- 3 Save the setting. Press the [Set] key. The balance returns to the weight display.



6-4-1 Data format

- 7-digit numeric format

Consists of 15 characters including terminators (CR=0DH/LF=0AH), to which a parity bit can be added.

1	2	3	4	5	6	7	8	9	10	11	12	13	14	15
P1	D1	D2	D3	D4	D5	D6	D7	D8	U1	U2	S1	S2	CR	LF

- Extended 7-digit numeric format

This is an extended version of the 7-digit numeric format and is different from the 7-digit numeric format in that:

- the data length can be set to seven bits, and
- the stop bit length can be one bit.
- If you select Japanese (katakana) as the print language, the data length is automatically set to eight bits.

- 8-digit numeric format

Consists of 16 characters including terminators (CR=0DH/LF=0AH), to which a parity bit can be added.

1	2	3	4	5	6	7	8	9	10	11	12	13	14	15	16
P1	D1	D2	D3	D4	D5	D6	D7	D8	D9	U1	U2	S1	S2	CR	LF

- Extended 8-digit numeric format

This is an extended version of the 8-digit numeric format and is different from the 8-digit numeric format in that:

- the data length can be set to seven bits, and
- the stop bit length can be one bit.
- If you select Japanese (katakana) as the print language, the data length is automatically set to eight bits.

6-4-2 Meanings of data

[P1] (one character)

Indicates the polarity of data.

P1	Code	Description
+	2BH	Zero or positive data
-	2DH	Negative data

[D1 to D7 (or D8)] (seven or eight characters)

Stores numeric data.

D1 to D7 (D8)	Code	Description
0 to 9	30H to 39H	0 to 9 (numeric)
•	2EH	<ul style="list-style-type: none"> • Decimal point (floating) • Omitted when numeric data does not contain decimal places. In this case, a space is output after the least significant digit.
SP (Space)	20H	<ul style="list-style-type: none"> • A space at the front of a numeric value • When numeric data does not contain decimal places, a space rather than a decimal point is output after the least significant digit.

- *• By default, 0 (30H) is used to begin numeric values that do not begin with data. Using the function setting, such values can begin with spaces (20H).
- When expression units are changed or switched to display counting, percentage weighing, or unit conversion, the decimal place is changed (“■ Communication format examples”).

[U1, U2] (two characters)

Indicates the unit used to show numeric data.

U1	U2	code		Meaning	Balance indicators
M	G	4DH	47H	milligram	mg
(SP)	G	20H	47H	gram	g
C	T	43H	54H	carat	<i>ct</i>
O	Z	4FH	5AH	ounce	<i>oz</i>
L	B	4CH	42H	pound	<i>lb</i>
O	T	4FH	54H	troy ounce	<i>oz t</i>
D	W	44H	57H	pennyweight	<i>dwt</i>
G	R	4BH	52H	Grain	GN
T	L	54H	4CH	tael (Hong Kong)	<i>ti</i>
T	L	54H	4CH	tael (Singapore, Malaysia)	<i>ti</i> ▶ Top right
T	L	54H	4CH	tael (Taiwan)	<i>ti</i> ▶ Bottom right
M	O	4DH	4FH	momme	mom
t	o	74H	6FH	tola	<i>to</i>
P	C	50H	43H	parts counting	Pcs
(SP)	%	20H	25H	percentage weighing	%
(SP)	#	20H	23H	Coefficient computation result	#

[S1] (one character)

Indicates the judgment result when the limit function is used.

S1	Code	Description	Remarks
L	4CH	Below (LO)	1- or 2-point scale
G	47H	Appropriate (OK)	
H	48H	Above (HI)	
1	31H	Rank 1	3- or 4-point scale
2	32H	Rank 2	
3	33H	Rank 3	
4	34H	Rank 4	
5	35H	Rank 5	
T	54H	Cumulative value	Data type
U	55H	Unit weight	
(SP)	20H	No judgment result or no data type specified	
d	64H	Gross	

[S2] (one character)

Indicates the status.

S2	Code	Description
S	53H	Data stable *1
U	55H	Data unstable *1
E	45H	Data error *2 (Indicates that data other than S2 is invalid.)
(SP)	20H	No status specified

*1: This value is independent of data if the data is independent of whether the weighing condition is stable or not, such as cumulative values and unit weights.

*2: When “o-Err” or “u-Err” is displayed

Output data other than measurement data

When the following data is output, the printer control command is added before and after the output data.

(1) Interval output

The header and footer are output at the start and end of interval output.

Header

15 “-” characters and the terminators (CR=0DH, LF=0AH) are output.

1	2	3	4	5	6	7	8	9	10	11	12	13	14	15
-	-	-	-	-	-	-	-	-	-	-	-	-	-	-

Footer

Two line feeds are output.

(2) Time output

When the time output function is set, the time is output in the line before the output data.

1	2	3	4	5	6	7	8	9	10
h	h	:	m	m	:	s	s	CR	LF

..* hh: hours (00 to 23), mm: minutes (00 to 59), ss: seconds (00 to 59)

6-4-3 Communication format examples

- 7-digit numeric format

3000.1 g/No data type specified/Data stable

1	2	3	4	5	6	7	8	9	10	11	12	13	14	15
+	0	0	3	0	0	0	.	1	(SP)	G	(SP)	S	CR	LF

+10.05 mom/Gross/Data unstable

1	2	3	4	5	6	7	8	9	10	11	12	13	14	15
-	0	0	0	1	0	.	0	5	M	O	d	U	CR	LF

250 pcs./Cumulative value/Data stable

1	2	3	4	5	6	7	8	9	10	11	12	13	14	15
+	0	0	0	0	2	5	0	(SP)	P	C	T	S	CR	LF

6-4-4 Special formats

Data formats

- Special format 1

Consists of 16 characters including terminators (CR=0DH/LF=0AH).

1	2	3	4	5	6	7	8	9	10	11	12	13	14	15	16
P1	SP	D1	D2	D3	D4	D5	D6	D7	D8	SP	U1	U2	U3	CR	LF

- Special format 2

Consists of 18 to 20 characters including terminators (CR=0DH/LF=0AH).

1	2	3	4	5	6	7	8	9	10	11	12	13	14	15	16	17	18	19	20
S1	S2	S3	SP	D1	D2	D3	D4	D5	D6	D7	D8	D9	D10	SP	U1	U2	U3	CR	LF

Meanings of special format 1 data

[P1] (one character)

Indicates the polarity of data.

P1	Code	Description
+	2BH	Zero or positive data
-	2DH	Negative data

[SP, D1 to D8]

Stores numeric data.

D1 to D8	Code	Description
0 to 9	30H to 39H	0 to 9 (numeric) right-aligned
•	2EH	Decimal point (floating)
SP (Space)	20H	<ul style="list-style-type: none"> • Spaces at the front and back of a numeric value • Spaces in the digit places where there is no numeric value

[U1, U2, U3] (three characters)

Indicates the unit used to show numeric data.

U1	U2	U3	Code			Meaning	Balance indicator
g	—	—	67H	—	—	gram	g
m	g	—	6DH	67H	—	milligram	mg
c	t	—	63H	74H	—	carat	CT
o	z	—	6FH	7AH	—	ounce	oz
l	b	—	6CH	62H	—	pound	lb
o	z	t	6FH	7AH	74H	troy ounce	oz t
d	w	t	64H	77H	74H	pennyweight	dwt
g	r	—	67H	72H	—	Grain	Bottom right ▷ grain
t	l	h	74H	6CH	68H	tael (Hong Kong)	tl
t	l	s	74H	6CH	73H	tael (Singapore, Malaysia)	tl Top right
t	l	t	74H	6CH	74H	tael (Taiwan)	tl Middle right
m	o	m	6DH	6FH	6DH	momme	mom
t	o	l	74H	6CH	61H	tola	to
p	c	s	70H	63H	73H	Pieces	Pcs
%	—	—	25H	—	—	Percentage	%
#	—	—	23H	—	—	unit converting	#

For output when the balance is unstable, the unit (three characters) becomes a space (20H).

Communication format examples for special format 1

123.4567 g/No data type specified/Data stable

1	2	3	4	5	6	7	8	9	10	11	12	13	14	15	16
+	SP	1	2	3	.	4	5	6	7	SP	g	SP	SP	CR	LF

Scale overload “o-Err”

1	2	3	4	5	6	7	8	9	10	11	12	13	14	15	16
SP	SP	SP	SP	SP	SP	H	SP	SP	SP	SP	SP	SP	SP	CR	LF

In the case of scale underload “u-Err,” “L” is output as the seventh character.

Meanings of data in special format 2

[S1 to S3] (three characters)

Indicates stable/unstable.

S1	S2	S3	S1 code	S2 code	S3 code	Meaning
S	(SP)	S	53H	20H	53H	Stable
S	(SP)	D	53H	20H	44H	Unstable

[SP, D1 to D10]

Stores numeric data.

D1 to D10	Code	Description
0 to 9	30H to 39H	0 to 9 (numeric) right-aligned
.	2EH	Decimal point (floating)
-	2DH	Polarity negative “-”
SP (Space)	20H	<ul style="list-style-type: none"> • Polarity positive “+” or zero • Spaces at the front and back of a numeric value • Spaces in the digit places where there is no numeric value

[U1, U2, U3] (three characters)

Indicates the unit used to show numeric data.

U1	U2	U3	Code			Meaning	Balance indicator
g	-	-	67H	-	-	gram	g
m	g	-	6DH	67H	-	milligram	mg
c	t	-	63H	74H	-	carat	CT
o	z	-	6FH	7AH	-	ounce	oz
l	b	-	6CH	62H	-	pound	lb
o	z	t	6FH	7AH	74H	troy ounce	oz t
d	w	t	64H	77H	74H	pennyweight	dwt
g	r	-	67H	72H	-	Grain	Bottom right ▷ grain
t	l	h	74H	6CH	68H	tael (Hong Kong)	tl
t	l	s	74H	6CH	73H	tael (Singapore, Malaysia)	tl Top right
t	l	t	74H	6CH	74H	tael (Taiwan)	tl Middle right
m	o	m	6DH	6FH	6DH	momme	mom
t	o	l	74H	6CH	61H	tola	to
p	c	s	70H	63H	73H	Pieces	Pcs
%	-	-	25H	-	-	Percentage	%
#	-	-	23H	-	-	unit converting	#

This is variable-length data and the number of characters varies between 1 to 3.

Communication format examples for special format 2

123.4567 g/No data type specified/Data stable

1	2	3	4	5	6	7	8	9	10	11	12	13	14	15	16	17	18
S	SP	S	SP	SP	SP	1	2	3	.	4	5	6	7	SP	g	CR	LF

Scale overload "o-Err"

1	2	3	4	5
S	SP	+	CR	LF

In the case of scale underload "u-Err," "-" is output as the third character.

6-5 Input Commands

Use these commands to control the balance from an external device.

- (1) Tare range setting command, (2) Output control setting command, (3) Measurement mode setting command, (4) Date output request and time output request command, (5) Interval time setting command, (6) Span adjustment and span test command, and (7) Limit value setting command

6-5-1 Procedure for transmission

(1) An input command is sent from an external device to the balance.

The full-duplex transmission system allows you to send input commands at any time regardless of the data transmit timing of the balance.

(2) Upon successful completion of an input command, the balance will send either a normal completion response or the result data requested by the command to the external device.

- If the operation has not resulted in successful completion, or if the command is invalid (an error), the balance will transmit an error response.
- When the balance is in normal display mode, it usually sends a response to a command within one second of receiving the command. For the tare range, span adjustment or span test commands, a response is sent after the commands are completely processed.
- If the balance receives a tare range setting command when the function setting for tare range (function setting H.tr) is set to “wait for the balance to stabilize for zero-point adjustment (waiting for the balance to stabilize),” or if the balance receives an input command that takes a long time, the balance sends a response after the command is completely processed.
- If the balance receives a command when you are setting a function, when the balance is under span adjustment, or the balance is busy for other reasons, the command is executed after the current operation has been completed.

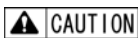

After you have sent an input command, do not send another command to the balance until the external device receives a response from the balance.

6-5-2 Input command examples

Sent command	Description
T(SP)(CR)(LF)	Set the tare range (adjust the zero point).
O1 (CR)(LF)	Set to continuous output.
O8 (CR)(LF)	Output data (once immediately).

6-5-3 Command format

An input command consists of 4 characters including terminators (CR/LF).

C1	C2	CR	LF
----	----	----	----

6-5-4 Format of each command



Pay attention to the difference between O (the letter "o") and 0 (zero).

(1) Tare range setting (zero-point adjustment) command

C1	C2	Code (C1)	Code (C2)	Description	Value	Acknowledgment
T	(SP)	54H	20H	<ul style="list-style-type: none"> • Tare range setting • Zero-point adjustment 	None	A00:Successful completion E01:Command error E04:The tare range cannot be set (zero point cannot be adjusted) (range violation, weight error, etc.).

(2) Output control setting command

C1	C2	Code (C1)	Code (C2)	Description	Response
O	0	4FH	30H	Stop output.	A00:Successful completion E01:Command error
O	1	4FH	31H	Output continuously at all times.	
O	2	4FH	32H	Output continuously if stable (Stop output if unstable).	
O	3	4FH	33H	Output once when the [Print] key is pressed (whether the balance is stable or unstable).	
O	4	4FH	34H	Output once when the balance is stable. Output when a sample is removed, causing the display to go below zero, and then another sample is placed, stabilizing the balance.	

C1	C2	Code (C1)	Code (C2)	Description	Response
O	5	4FH	35H	Output once when the balance is stable. Stop output when unstable. Output once when the balance has restabilized (the output includes zero) even if it is not reloaded.	A00:Successful completion E01:Command error
O	6	4FH	36H	Output once when the balance is stable. Output continuously when unstable. Output is stopped after a single output when the balance is stable even if it is not reloaded.	
O	7	4FH	37H	Output once when the [Print] key is pressed if the balance is stable.	
O	8	4FH	38H	Output once immediately.	
O	9	4FH	39H	Output once after stabilizing.	
O	A	4FH	41H	Interval function (Output once each time the output time has elapsed)	
O	B	4FH	42H	Interval function (Output once during stabilization, each time the output time has elapsed)	

- Commands O0 to O7 have the same functions as the output control set by the function setting.
- Commands O8 and O9 are used to request data from the balance.
- Once the O0 to O7 commands are executed, that state is maintained. However, the status is reset to the function setting when the balance is turned on again.
- When the OA or OB command is input, the interval function starts, and when input again, the interval function ends.
- After the O8 or O9 command is executed, it returns to "O0."

(3) Measurement mode setting command

C1	C2	Code (C1)	Code (C2)	Description	Response
M	1	4DH	31H	Set to Mode 1	A00: Successful completion E01: Command error E02: Error
M	2	4DH	32H	Set to Mode 2	
M	3	4DH	33H	Set to Mode 3	
M	4	4DH	34H	Set to Mode 4	

- * The measurement mode activated by mode settings 1 to 4 depends on the weighing mode currently in use.

• Relationships between weighing modes and mode settings

Mode	Simple weight measurement	Counting	Percentage weighing	Unit conversion	Gravimeter/Statistical operation function
Mode 1	Weight measuring	Weight measuring	Weight measuring	Weight measuring	Error
Mode 2	Gross weight	Counting	Percentage measuring	Coefficient multiplying	Error
Mode 3	Cumulative weight ^{*1}	Cumulative count ^{*1}	Cumulative percent ^{*1}	Cumulative coefficient ^{*1}	Error
Mode 4	Display in unit b ^{*2}	Average unit weight	Error	Error	Error

*1: Mode 3 (M3) can only be specified when the addition function is used. If the addition function is not enabled, it results in an error.

*2: If unit b is set to NONE, the balance is set to the weight measuring mode. When you specify a mode that is not supported by the current Weighing Mode, an error is returned from the balance.

(4) Date output request and time output request

C1	C2	Code (C1)	Code (C2)	Description	Response
D	D	44H	44H	Date output request	A00: Successful completion E01: Command error
D	T	44H	54H	Time output request	

1: Content of date data

DATE:yyyy.mm.dd(CR)(LF) English
 Date: yyyy.mm.dd(CR)(LF) Japanese (katakana)

2: Content of time data

TIME:yyyy.mm.dd(CR)(LF) English
 Time:yyyy.mm.dd(CR)(LF) Japanese (katakana)

When the above data is output, the printer control command is added to it.

* The output content can be set to be in English or Japanese (katakana) using the function setting “G3.P.F.” (print language).

* The order in which the year, month, and day appear depends on how the function setting “H.dAtE” (date display) is set.

(5) Interval (output) time setting command

C1	C2	Code (C1)	Code (C2)	Description	Value	Response
I	A	49H	41H	Interval time setting	Interval time	A00: Successful completion E01: Command error E02: Interval time setting error

* Delimit the command, hour, minute and second with commas “,” (2CH), for example, “IA,hh,mm,ss.”

(6) Span adjustment and span test command

C1	C2	Code (C1)	Code (C2)	Description	Response
C	0	43H	30H	Disables command inputs.*1	A00: Successful completion E01: Command error E02: Operation is disabled. E03: Cancelled by operation E04: Abnormal completion
C	1	43H	31H	Span adjustment with internal weight	
C	2	43H	32H	Span test with internal weight	
C	3	43H	33H	Span adjustment with external weight	
C	4	43H	34H	Span test with external weight	

*1: Span adjustment and test commands will also be disabled.

* This command takes time because the balance sends back a response after the current operation is completed.

* If the function setting “8.CA.” is set to “[Cal] key disabled” (0), the span adjustment command does not work.

(7) Limit value setting command

C1	C2	Code (C1)	Code (C2)	Description	Value	Response
L	A	4CH	41H	First set point/ Lower limit	Limit value	A00: Successful completion E01: Command error E02: Value setting error
L	B	4CH	42H	Second set point/ Upper limit		
L	C	4CH	43H	Reference		
L	D	4CH	44H	Third set point		
L	E	4CH	45H	Fourth set point		

* Delimit the command and the limit value with a comma “,” (2CH), for example, “LA,nnn.”

* Enter a value with no unit.

* When the balance is in simple weight measurement mode, the entered value is recognized in the unit registered as Unit A. For example, if the command “LA,20.00” is sent, the balance takes it as 20.00 g if Unit A is set to grams or 20.00 ct if Unit A is set to carats.

* When the balance is in counting, percentage weighing or unit conversion mode, the unit of limit values is PCS, % or # respectively.

6-6 Response

Upon receiving an input command, the balance sends out a response.

You can select the response format of either the ["A00"/"Exx"] format or the [ACK/NAK] format.

The ["A00"/"Exx"] format responses are described in the explanation of "input commands" in the previous section.

- ["A00"/"Exx"] format]

Consists of five characters including terminators. For more information on A1 to A3, see the "Response" fields in the previous section.

A1	A2	A3	CR	LF
-----------	-----------	-----------	-----------	-----------

- [ACK/NAK] format

Consists of one character without a terminator. "Successful completion" (ACK) or "Abnormal completion" (NAK) is returned.

Response	Code	Meaning
ACK	06H	Successful completion
NAK	15H	<ul style="list-style-type: none"> • Command error (when an erroneous command is received) • Numeric format error • Processing interrupted • Processing terminated abnormally • Other errors

Reference

To switch between the ["A00"/"Exx"] format and [ACK/NAK] format, use the "67.rS" function setting.

1: ["A00"/"Exx"] format

2: [ACK/NAK] format

7 Troubleshooting

7-1 Error Messages

Message	Cause	Remedy
o-Err	<ul style="list-style-type: none"> The weight of the sample is more than the weighing capacity. The number of digits in the addition result or calculation result went beyond the largest number that can be displayed. 	<ul style="list-style-type: none"> Unload the sample and weigh it in parts. Replace the tare with a lighter one. If the error message does not disappear even when nothing is placed on the weighing pan, mechanical parts may have failed. Please contact the retailer from whom the balance was purchased. First, clear the addition result. Then execute the addition again. The coefficient used for unit conversion is too small. Set a larger coefficient.
u-Err	The negative load exceeded the lower limit.	<ul style="list-style-type: none"> The weighing pan or the pan base may not be set properly. Check whether they are in contact with an object or if there is some other problem with them. If the error message does not disappear even if the weighing pan and pan base are properly set, mechanical parts may have failed. Please contact the retailer from whom the balance was purchased.

Message	Cause	Remedy
1-Err	The reference weight used during span adjustment or span test with an external weight is far less than 50% of the weighing capacity.	Use a weight that is as close to the weighing capacity as possible.
2-Err	An error over 1.0% was detected in span adjustment or span test with an external weight, or the balance failed.	Check that the correct weight was put in place and that no objects other than the weight are on the pan. Then, execute span adjustment or span test again.
b-Err	The balance is influenced by static electricity or noise.	<ul style="list-style-type: none"> • Unplug the AC adapter from the receptacle and then turn the power on again. • If this error occurs again, electric components may have failed. Please contact the retailer from whom the balance was purchased.
d-Err	The balance is influenced by static electricity or noise.	<ul style="list-style-type: none"> • Unplug the AC adapter from the receptacle and then turn the power on again. • If this error occurs again, electric components may have failed. Please contact the retailer from whom the balance was purchased.
L-Err	The weight of a sample is too light to take samples for counting, or for reference weight saving during percentage weighing.	Use a heavier sample by referring to the Specifications to check the minimum unit weight and the percentage weighing weight limit.
t-Err	<ul style="list-style-type: none"> • While using the addition operation, two additional samples were placed on the balance at once. • The addition operation was performed when zero or a negative value is displayed. 	<ul style="list-style-type: none"> • After returning the display to "0" (by removing the previous sample), place the next sample on the balance to continue the addition operation. • Addition operations are impossible when 0 or a negative value is displayed. Place a sample on the balance to continue the addition operation.

Message	Cause	Remedy
E1-Err	No input is being sent from the weight sensor.	<ul style="list-style-type: none">• Unplug the AC adapter from the receptacle and then turn the power on again.• If this error occurs again, the sensor may be malfunctioning. Please contact the retailer from whom the balance was purchased.
E2-Err	Initialization cannot be completed because the balance is unstable.	The balance may be affected by an external influence such as wind and vibration. Relocate the balance by referring to instructions about the place of installation described in Section 1-1 “Warnings regarding Use.”

7-2 Troubleshooting

Problem	Cause	Remedy
Nothing is displayed even when the balance is powered on.	The AC adapter is not connected.	<ul style="list-style-type: none"> • Check that the AC adapter is connected. • If nothing is displayed even if the AC adapter plug is properly connected, the electric components of the balance or the AC adapter may have failed. Replace the AC adapter to test whether the adapter was the problem if you have an AC adapter of the same model that you know operates properly. • Please contact the retailer from whom the balance was purchased.
The display flickers.	The balance may be affected by an external influence such as wind and vibration.	Increase the setting values of relevant functions by referring to Section 5-11 "Improving the Stability of the Balance."
The displayed weight is incorrect.	This error is caused by the balance not being used for a long period of time or being relocated.	Perform span adjustment.
	The adjusters are not resting flat on the surface and the balance is not horizontal.	Make sure that the balance is horizontal.
	The tare range is set or is not set.	Unload the sample from the weighing pan and then zero the readout by pressing the [Zero/Tare] key to continue measurement.

Problem	Cause	Remedy
The weight indication contains an error even after it is calibrated.	The balance may have been affected by an external influence such as wind and vibration during calibration.	The balance may be affected by an external influence such as wind and vibration. Take remedial actions or relocate the balance by referring to instructions about the place of installation described in Section 1-1 “Warnings regarding Use.” Then calibrate it again.
	The weight used for calibration is slightly different in mass from the weight used for checking.	Use the same weight during calibration and checking.
The M continuously flashes. (When the [Zero/Tare] key is pressed when taking samples in counting mode, etc.)	The balance may be affected by an external influence such as wind and vibration.	The balance may be affected by an external influence such as wind and vibration. Take remedial actions or relocate the balance by referring to instructions about the place of installation described in Section 1-1 “Warnings regarding Use.”
Unable to output anything	The output function settings may not have been set as you intended.	Match the balance’s communication conditions with the external device by

Problem	Cause	Remedy
	<p>Communication conditions do not match those of the external device.</p>	<p>referring to their operation manuals. Check output by:</p> <p>Initialize the function settings by referring to Section 7-3 “Initializing” or Function Setting List.</p> <p>Then, set communication conditions 1,200 bps, 8-bit data, 2-bit stop bit, and no parity by referring to the operation manual of the external device.</p> <p>With these settings, after the [Print] key is pressed and once the balance has stabilized, output is done once. Check the output by pressing the [Print] key.</p>
	<p>Wrong cable connection</p>	<p>To connect the balance to a common PC, a crossover cable is required (Refer to Section 6-2 “Connecting to External Devices via the RS-232C Interface”).</p> <p>Obtain one yourself or contact the retailer from whom the balance was purchased.</p>
	<p>The cable is disconnected or not properly connected.</p>	<p>Make sure that the cable is connected properly.</p>
<p>To reset the balance to the initial settings at the time of purchase.</p>		<p>The balance can be re-initialized (Section 7-3 “Initializing”).</p>

7-3 Initializing

The settings of the balance can be initialized by following these steps:

- 1** Go to the function 2 setting mode.

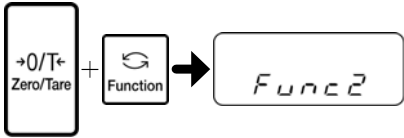

While pressing the [Zero/Tare] key, press and hold the [Function] key. After "Func2" is displayed, release the keys.

The function 2 setting mode is set, displaying "1. ID 0."
- 2** Set the function initialization.

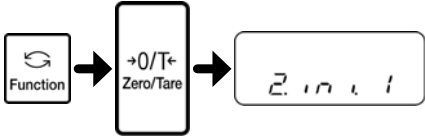

Press the [Function] key to select "2. in i."

Press the [Zero/Tare] key to select "1."
- 3** Save the setting.



Press the [Set] key.

The balance returns to the weight display.



All function settings are initialized, discarding all data including ID numbers, limit values, as well as all counting, percentage weighing, unit conversion, and gravimeter data.

Restoring the information once it has been initialized is impossible. Before initializing the balance, record necessary function settings by writing them down.

7-4 Maintenance

When performing maintenance on the balance, be careful of the following:

7-4-1 For heavy dirt

It is easy to remove the right and left doors of the windshield, and the weighing pan, the pan base, the windshield ring and the bottom plate in the weighing chamber, so that you can clean the balance. Unplug the AC adapter before cleaning the balance.



Be sure to unplug the AC adapter before cleaning the balance.

■ Removing the windshield doors

(1) Push down the lower knob of the doors you want to remove until they are free.

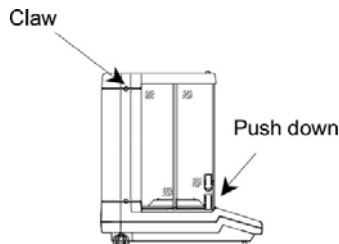

(2) Remove the door storage cover by pushing the upper part of the claw down and tilting the cover toward you.

Remove the door storage cover.

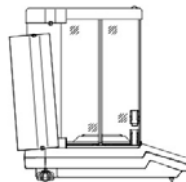

(3) Remove the doors by pushing them backward.

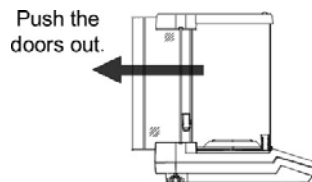

(4) Attach the doors in the reverse order of removal. When attaching the doors, bring the two doors together with the door having the knob facing the inside.



The four doors have different shapes. To attach them properly, you should only remove the doors on one side at a time. When attaching the doors, pay close attention to their directions.

■ Removing the weighing pan, the pan base, the windshield ring and the bottom plate in the weighing chamber

Lift the windshield ring. At the same time, you can remove the pan base and the weighing pan.

To remove the bottom plate, hold both sides of the bottom plate with both hands and pull it up.

Attach the bottom plate, the windshield ring, the pan base, and the weighing pan in this order.

7-4-2 How to clean the balance

To clean the main unit, wipe it down with a wet soft cloth that has been thoroughly wrung out.



Do not use any strong solvents or abrasive cleansers.

Take care not to allow liquid or dirt to enter the main unit (mechanical parts).

(Memo)

Appendixes

Appendix 1 Function Setting List

☆:Initial setting

[Function 1]

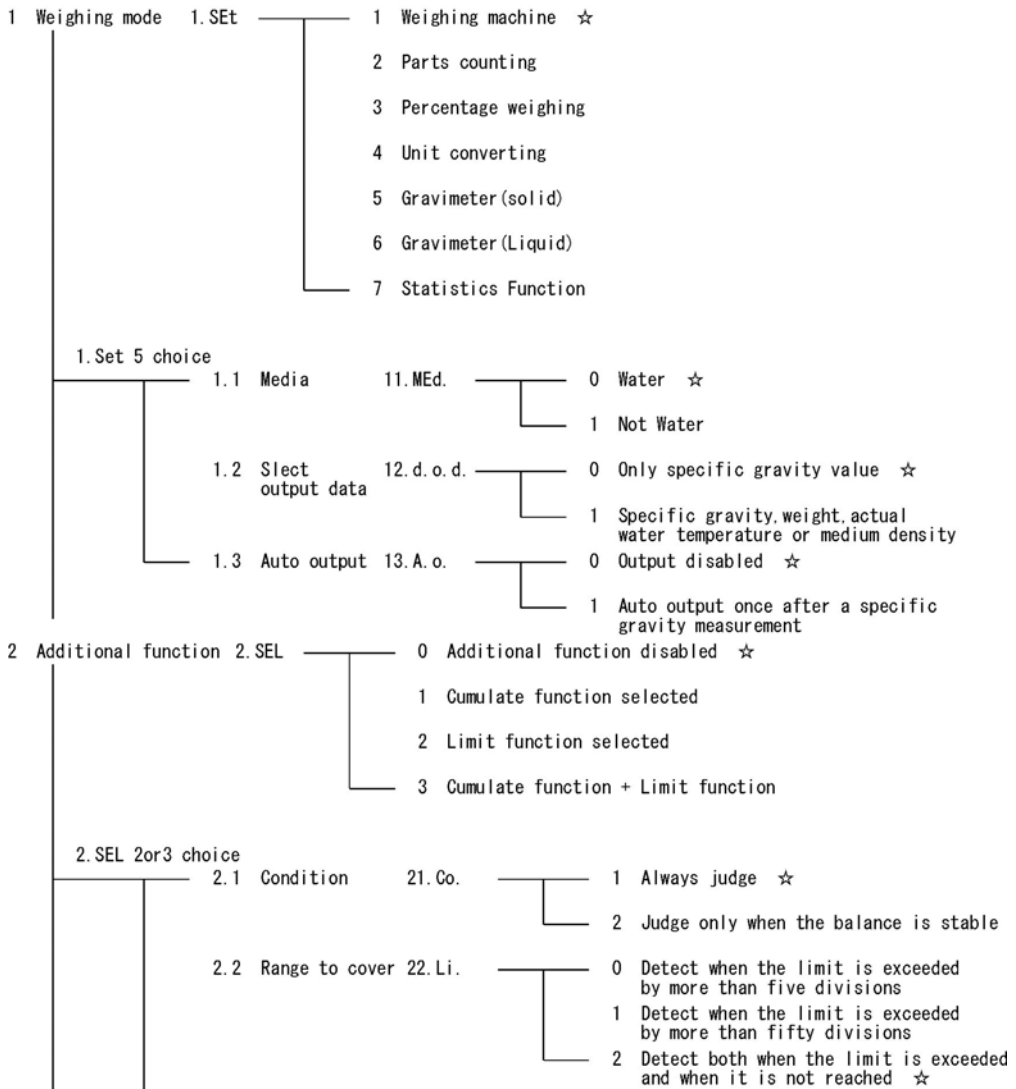

☆:Initial setting

2.3	Point scale	23.Pi.	1	1-point scale (OK/LO are judged)			
			2	2-point ☆			
			3	3-point			
			4	4-point			
			2.4	Judge by	24.tYP.	1	Judge by absolute value ☆
						2	Judge by deviation value
			2.5	Rank 1 Buzzer when LO is judged	25.bu.1	0	Buzzer not beeped for rank LO ☆
						1	Buzzer beeped for rank LO
			2.6	Rank 2 Buzzer when OK is judged	26.bu.2	0	Buzzer not beeped for rank OK ☆
						1	Buzzer beeped for rank OK
2.7	Rank 3 Buzzer when HI is judged	27.bu.3	0	Buzzer not beeped for rank HI ☆			
			1	Buzzer beeped for rank HI			
2.8	Rank 4 Distinction buzzer	28.bu.4	0	Buzzer not beeped for rank 4 ☆			
			1	Buzzer beeped for rank 4			
2.9	Rank 5 Distinction buzzer	29.bu.5	0	Buzzer not beeped for rank 5 ☆			
			1	Buzzer beeped for rank 5			
2.10	How to indicate results	2A.LG.	1	HI/OK/LO ☆			
			2	2-point bar graph (Available only for 2-point scale)			
2.SEL 1or3 choice							
2.11	Addition operation	2b.Ad.M	1	Cumulate ☆			
			2	Net addition			
2.12	Addition direction	2C.Add.	1	Positive side addition ☆			
			2	Negative side addition			

☆:Initial setting

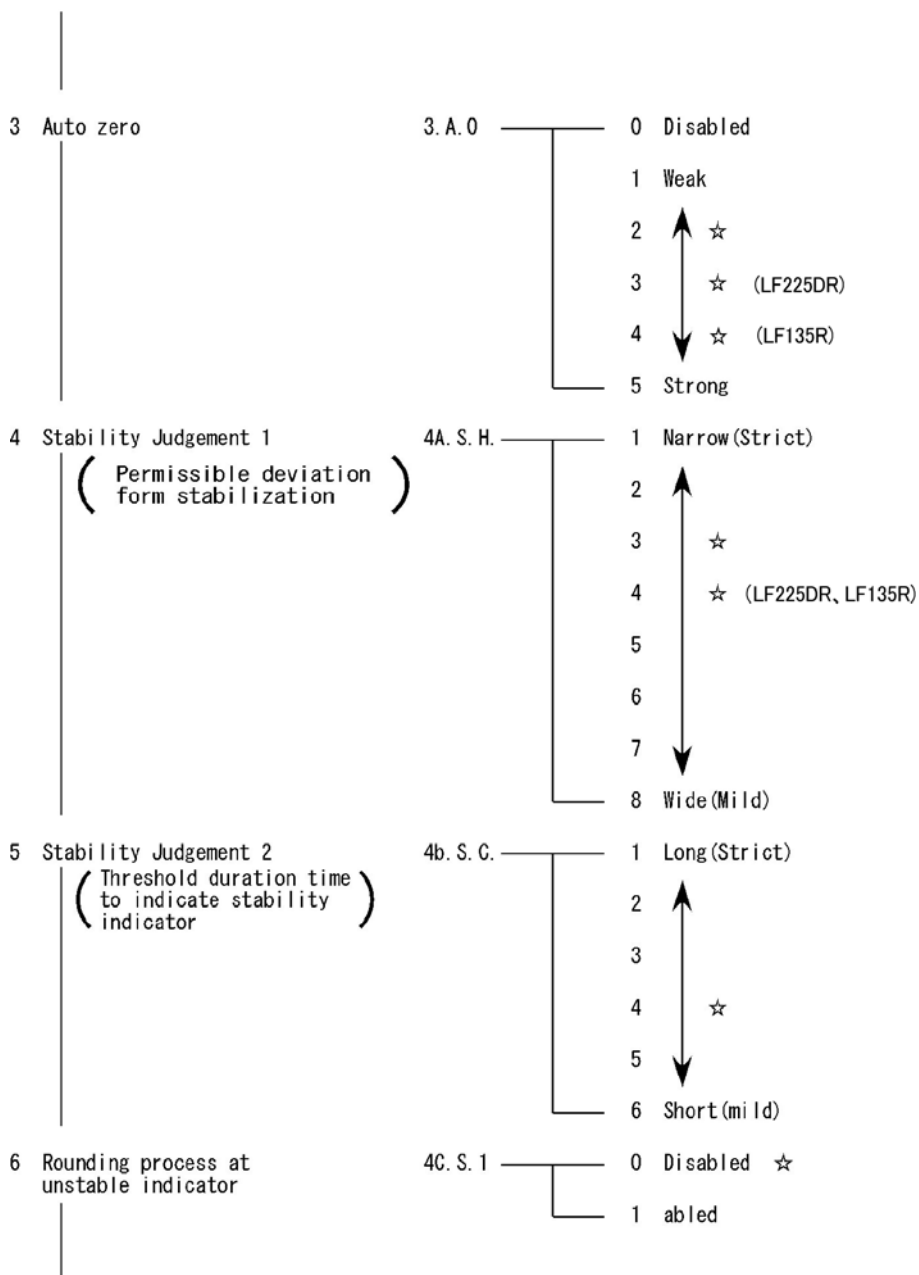

☆:Initial setting

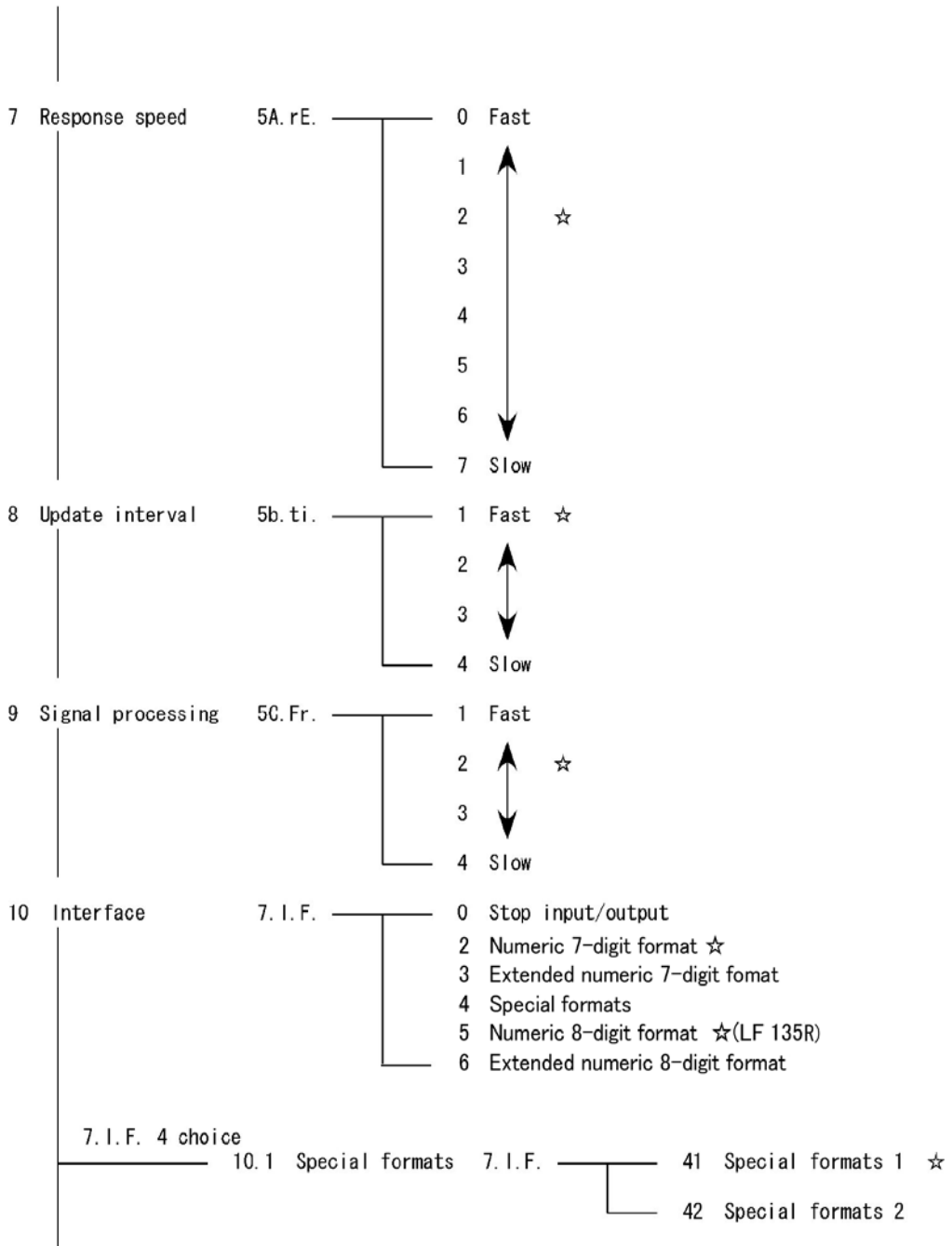

☆:Initial setting

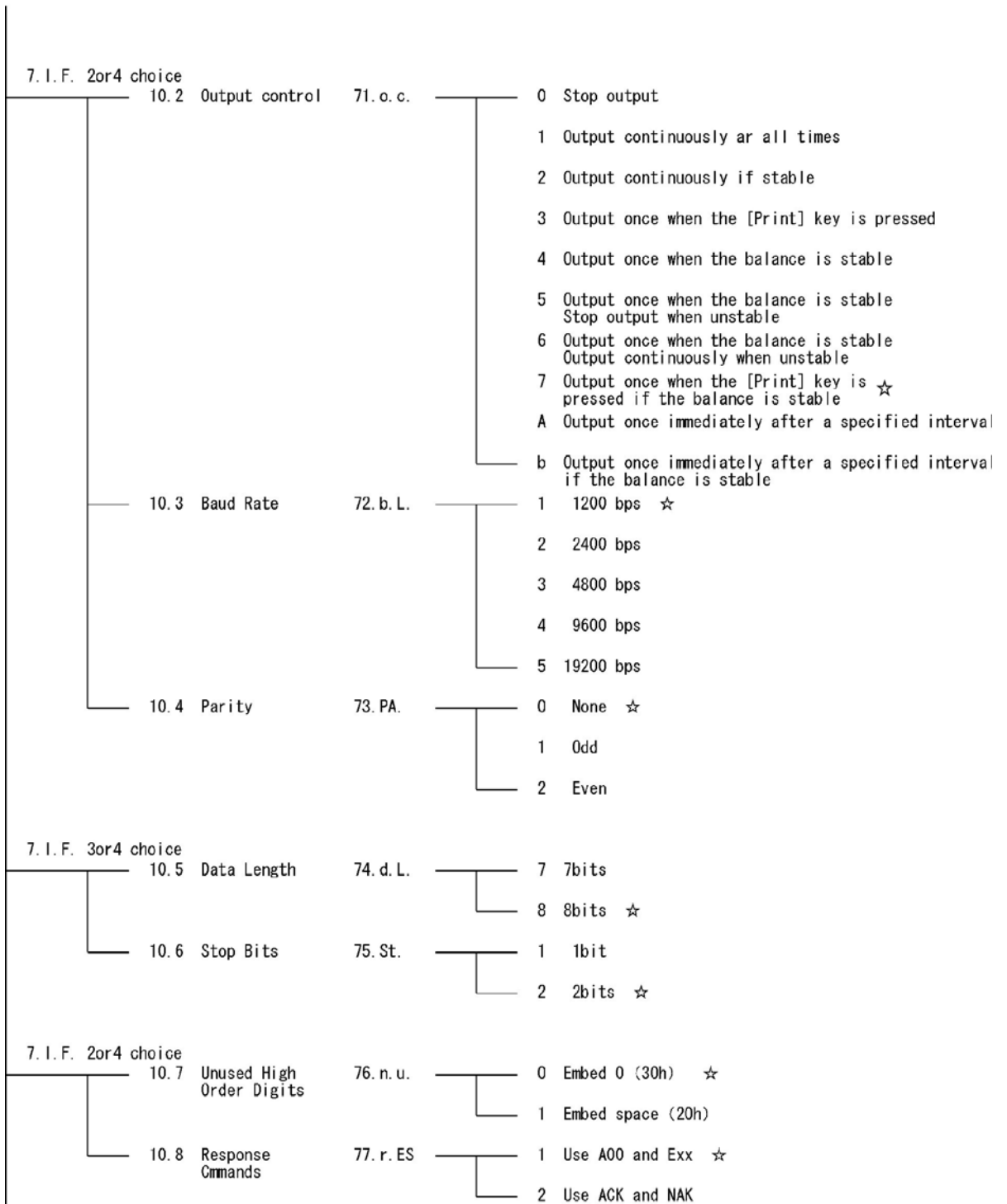

☆:Initial setting

11	Span adjustment	8. CA.	<ul style="list-style-type: none"> 0 CAL operation disabled 1 Span adjustment using built-in weights ☆ (Only as for LFR type) 2 Span test using built-in weights (Only as for LFR type) 3 Span adjustment with external weight ☆ 4 Span test with external weight
12	Bar graph	9. b. G.	<ul style="list-style-type: none"> 0 Not displayed 1 Displayed ☆
13	Auto backlight OFF	A. A. b	<ul style="list-style-type: none"> 0 Disable 1 Enable ☆
14	Unit setting (Unit A)	b1. u. A	<ul style="list-style-type: none"> 1 mg (milligram) 2 g (gram) ☆ 4 ct (carat) 5 oz (ounce) 6 lb (pound) 7 ozt (troy ounce) 8 dwt (penny weight) 9 GN (grain) A t1 (tael (Hong Kong)) b t1 Upper right ► (tael (Singapore, Malaysia)) C t1 Right middle ► (tael (Taiwan)) d mom (momme) E to (tole)

		☆:Initial setting	
15	Minimum readability setting (Unit A) b2.d.A (Other than LF225DR)	—	1 Fine ☆ 2 ↑ 3 ↔ 4 ↓ 5 Rough
16	Unit setting (Unit b)	b3.u.b	0 None ☆ 1 mg (milligram) 2 g (gram) 4 ct (carat) 5 oz (ounce) 6 lb (pound) 7 ozt (troy ounce) 8 dwt (penny weight) 9 GN (grain) A t1 (tael (Hong Kong)) b t1 Upper right ▶ (tael (Singapore, Malaysia)) C t1 Right middle ▶ (tael (Taiwan)) d mom (momme) E to (tole)
17	Minimum readability setting (Unit B) b4.d.b (Other than LF225DR)	—	1 Fine ☆ 2 ↑ 3 ↔ 4 ↓ 5 Rough
18	Automatic Switching of Scale intervals (Only as for LF 225DR)	C.d.r	0 Disabled 1 Enabled ☆
19	Assigned function to one-touch of Set key (Only as for LF 225DR)	d.o.t.c.	1 Respons speed change ☆ (Easy RES abled) 2 Minimum Read-out change (Easy RES disabled)
20	Se-GAL	E.Ad.G.	0 Disable ☆ 1 Advice CAL 2 Full-automatic Span Adjustment ☆ (Only as for LFR type)
21	Auto Repeatability Measurement	F.ArM.	1 Auto Repeatability Measurement (ARM) ☆ (Only as for LFR type) 2 Semiauto Repeatability Measurement (SARM)

☆:Initial setting

22	Compliance with ISO/GLP/GMP	G. GLP	0 Disable ☆ 1 Enable
	G. GLP 1 choice		
	19.1	Outputting calibration results	G1.out 0 Disabled 1 Enabled ☆
	19.2	Measurement data in compliance with GLP	G2.od. 0 Disabled ☆ 1 Enabled
	19.3	Language for printing	G3.P.F. 1 English ☆ 2 Japanese
23	date Display	H. dAtE	1 Output in Year-Month-day format 2 Output in Month-Day-year format 3 Output in Day-Month-Year format ☆
24	Time Stamp Output	J. t.o.	0 Disabled ☆ 1 Enabled
25	Set tare range	L. tA.	1 "0" is displayed immediately after the key is pressed 2 Reset the display to "0" when the balance is stabilized ☆
26	Store tare	n. tArE	0 Disabled ☆ 1 Enabled
27	Buzzer control	P. bZ.	0 Off 1 On (Beeps when a value is confirmed, wrong operation is made, etc) 2 Beeps when the key is pressed in addition to the beeping situations in 1 ☆
	P. bZ. 1or2 choice		
	24.1	Buzzer tone	P1. tn 1 Low 2 Middle ☆ 3 High
	24.2	Buzzer message	P2. b.M 0 Disabled ☆ 1 Enabled
28	Backlight control	r. b.L.	0 Off 1 On (30% of brightness) 2 On (70% of brightness) 3 On (100% of brightness) ☆

☆:Initial setting

[Function 2]

1	Setting of the ID number	1. Id	0 Disabled ☆ 1 Enabled
2	Setting of the Weight Error	2. o. M. P.	0 Disabled ☆ 1 Enabled
3	Calibration of Built-in Weight (Only as for LFR type)	3. r. CA.	0 Disabled ☆ 1 Enabled
4	Use the weight error	4. M. E. H.	0 Disabled ☆ 1 Using asaved weight error
5	α -Check	5. S. dn.	0 Disabled ☆ 1 Enabled
6	Initialize	6. ini.	0 Disabled ☆ 1 Enabled

[α -Check]

1	Display test	51. d. t.	0 Disabled ☆ 1 Enabled
2	Key test	52. K. t.	0 Disabled ☆ 1 Enabled
3	Motor test	53. M. t.	0 Disabled ☆ 1 Enabled
4	History of the span adjustment	54. S. c. t.	0 Disabled ☆ 1 Enabled
5	Auto Repeatability Measurement (Only as for LFR type)	55. ArM.	0 Disabled ☆ 1 Enabled
6	Semiauto Repeatability Measurement	56. SArM.	0 Disabled ☆ 1 Enabled

Appendix 2 Measurement Mode List

In each weighing mode, pressing the [Function] key switches the function displayed. Displayable functions differ between modes. The additional functions usable concurrently with each function also differ.

Weighing mode	Displayed functions switched with each press of the [Function] key				Additional function usable in each function		Remarks
	Switching order	Displayed function	Unit used	Displayed sign	Addition	Limit	
Simple weight measurement	1	Weight measuring	Unit A		Available	Available	
	2	Gross weight	Unit A	B/G	N/A	N/A	
	3	Weight measuring	Unit b		N/A	N/A	Displayed only when unit b is selected
	4	Cumulative weight	Unit A	Σ	Cumulative value	N/A	Displayed only when the addition function is selected
Counting	1	Counting	Pcs		Available	Available	
	2	Cumulative count	Pcs	Σ	Cumulative value	N/A	Displayed only when the addition function is selected
	3	Average unit weight	Unit A	Pcs	N/A	N/A	
	4	Weight measuring	Unit A		N/A	N/A	
Percentage weighing	1	Percentage measuring	%		Available	Available	
	2	Cumulative percent	%	Σ	Cumulative value	N/A	Displayed only when the addition function is selected
	3	Weight measuring	Unit A		N/A	N/A	
Unit conversion	1	Coefficient multiplying	#		Available	Available	
	2	Cumulative coefficient	#	Σ	Cumulative value	N/A	Displayed only when the addition function is selected
	3	Weight measuring	Unit A		N/A	N/A	
Gravimeter	1	Measurement of specific gravity	g		N/A	N/A	Unit for weight fixed to g

* For more information on unit A and unit b, refer to Section 5-1 "Select and Switch of Weighing Units."

Appendix 3 ISO/GLP/GMP Compliant Printing

When span adjustment, span test or α -check is successfully completed, the balance outputs the following:

Reference

The "ERR" and the instrumental error line is output when the instrumental error has been entered.

■ Span adjustment with internal weight

English	Japanese (Katakana)
<pre> **CALIBRATION** DATE:2012.01.01 TIME: 12:00 SHINKO DENSHI TYPE: XFR-225W S/N: 0123456789 ID: AB-123 CAL. INTERNAL REF: 220.0000 g COMPLETE DATE:2012.01.01 TIME: 12:01 SIGNATURE ***** </pre>	<pre> *** コウセイ *** ヒツケ:2012.01.01 シコク: 12:00 SHINKO DENSHI カタシキ: XFR-225W セイハ^ン0123456789 ID: AB-123 コウセイ(ナイフ^フント^ウ) キシ^ユン: 220.0000 g シュウリョク ヒツケ:2012.01.01 シコク: 12:01 シヨメイ ***** </pre>

■ Span adjustment with external weight

English	Japanese (Katakana)
<pre> **CALIBRATION** DATE:2012.01.01 TIME: 12:00 SHINKO DENSHI TYPE: XFR-225W S/N: 0123456789 ID: AB-123 CAL. EXTERNAL REF: 220.0000 g ERR: 0.12mg COMPLETE DATE:2012.01.01 TIME: 12:01 SIGNATURE ***** </pre>	<pre> *** コウセイ *** ヒツケ:2012.01.01 シコク: 12:00 SHINKO DENSHI カタシキ: XFR-225W セイハ^ン0123456789 ID: AB-123 コウセイ(カ^イフ^フント^ウ) キシ^ユン: 220.0000 g キサ: 0.12mg シュウリョク ヒツケ:2012.01.01 シコク: 12:01 シヨメイ ***** </pre>

■ Span test with internal weight

English

```

**CAL. TEST**

DATE:2012.01.01
TIME: 12:00
SHINKO DENSHI
TYPE: XFR-225W
S/N: 0123456789
ID: AB-123

CAL. INT. TEST
REF:
220.0000 g
DIFF: 0.0001 g

COMPLETE
DATE:2012.01.01
TIME: 12:01

SIGNATURE

*****

```

Japanese (Katakana)

```

*** テスト ***

ヒツケ:2012.01.01
シコク: 12:00
SHINKO DENSHI
カタシキ: XFR-225W
セイハン0123456789
ID: AB-123

ナイフノ (ナイフノ フントク)
キシン: 220.0000 g
コノサ: 0.0001 g

シュウリョク
ヒツケ:2012.01.01
シコク: 12:01

ショメイ

*****

```

■ Span test with external weight

English

```

**CAL. TEST**

DATE:2012.01.01
TIME: 12:00
SHINKO DENSHI
TYPE: XFR-225W
S/N: 0123456789
ID: AB-123

CAL. EXT. TEST
REF:
220.0000 g
ERR: 0.12mg
DIFF: 0.0001 g

COMPLETE
DATE:2012.01.01
TIME: 12:01

SIGNATURE

*****

```

Japanese (Katakana)

```

*** テスト ***

ヒツケ:2012.01.01
シコク: 12:00
SHINKO DENSHI
カタシキ: XFR-225W
セイハン0123456789
ID: AB-123

テスト (カノ イフノ フントク)
キシン: 220.0000 g
キサ: 0.12mg
コノサ: 0.0001 g

シュウリョク
ヒツケ:2012.01.01
シコク: 12:01

ショメイ

*****

```

■ Calibration of internal weight

English

Japanese (Katakana)

```

****REF. CAL****
DATE:2012.01.01
TIME: 12:00
SHINKO DENSHI
TYPE: XFR-225W
S/N: 0123456789
ID: AB-123

REF: 220.0000 g
ERR: 0.12mg

COMPLETE
DATE:2012.01.01
TIME: 12:01

SIGNATURE

*****
    
```

```

*ナイフ・フントウコウセイ*
ヒツケ:2012.01.01
シコク: 12:00
SHINKO DENSHI
カタシキ: XFR-225W
セイバノ0123456789
ID: AB-123

キシュン: 220.0000 g
キチ: 0.12mg

シュウリョウ
ヒツケ:2012.01.01
シコク: 12:01

ショメイ

*****
    
```

■ Measurement data: Header

English

Japanese (Katakana)

```

SHINKO DENSHI
TYPE: XFR-225W
S/N: 0123456789
ID: AB-123

START
DATE:2012.01.01
TIME: 12:00
    
```

```

SHINKO DENSHI
カタシキ: XFR-225W
セイバノ0123456789
ID: AB-123

カイシ
ヒツケ:2012.01.01
シコク: 12:00
    
```

■ Measurement data: Footer

English

Japanese (Katakana)

```

END
DATE:2012.01.01
TIME: 12:03

SIGNATURE

*****
    
```

```

シュウリョウ
ヒツケ:2012.01.01
シコク: 12:03

ショメイ

*****
    
```

■ α -check: Display test

English

```

***DSP. TEST***
DATE:2012.01.01
TIME: 12:00
SHINKO DENSHI
TYPE:
      XFR-225W
S/N: 0123456789
ID:  AB-123

DSP. TEST  DONE

COMPLETE
DATE:2012.01.01
TIME: 12:01

SIGNATURE

*****

```

Japanese (katakana)

```

**テラ イスラ レイラ スト**
ヒツラ ケ:2012.01.01
シラ コク: 12:00
SHINKO DENSHI
カクラ シキ:
      XFR-225W
セイラ ハラ ン0123456789
ID:  AB-123

DSP. TEST  DONE

シュウラ リョウ
ヒツラ ケ:2012.01.01
シラ コク: 12:01

ショラ メイ

*****

```

■ α -check: Key test

English

```

***KEY TEST ***
DATE:2012.01.01
TIME: 12:00
SHINKO DENSHI
TYPE:
      XFR-225W
S/N: 0123456789
ID:  AB-123

KEY TEST  OK

COMPLETE
DATE:2012.01.01
TIME: 12:01

SIGNATURE

*****

```

Japanese (katakana)

```

*** キーラ テスト ***
ヒツラ ケ:2012.01.01
シラ コク: 12:00
SHINKO DENSHI
カクラ シキ:
      XFR-225W
セイラ ハラ ン0123456789
ID:  AB-123

KEY TEST  OK

シュウラ リョウ
ヒツラ ケ:2012.01.01
シラ コク: 12:01

ショラ メイ

*****

```

■ α-check: Motor test

English

Japanese (katakana)

```

***MOT. TEST***
DATE:2012.01.01
TIME: 12:00
SHINKO DENSHI
TYPE:
      XFR-225W
S/N: 0123456789
ID: AB-123

MOT. TEST OK

COMPLETE
DATE:2012.01.01
TIME: 12:01

SIGNATURE

*****
    
```

```

*** モーターテスト ***
ヒツケ:2012.01.01
シコク: 12:00
SHINKO DENSHI
カタシキ:
      XFR-225W
セイハ`ン0123456789
ID: AB-123

MOT. TEST OK

シュウリョウ
ヒツケ:2012.01.01
シコク: 12:01

ショメイ

*****
    
```

■ Span adjustment history

English

Japanese (Katakana)

```

***CAL. HIST.***
DATE:2012.01.01
TIME: 12:00
SHINKO DENSHI
TYPE:
      XFR-225W
S/N: 0123456789
ID: AB-123

01
CAL. INTERNAL
DATE:2012.01.01
TIME: 08:15
TEMP: 23.5 C
DIFF:
      3 ppm

02
CAL. EXTERNAL
DATE:2012.01.01
TIME: 10:05
TEMP: 22.4 C
DIFF:
      1 ppm

COMPLETE
DATE:2012.01.01
TIME: 12:03

SIGNATURE

*****
    
```

```

** コウセイ リレキ **
ヒツケ:2012.01.01
シコク: 12:00
SHINKO DENSHI
カタシキ:
      XFR-225W
セイハ`ン0123456789
ID: AB-123

01
コウセイ(ナイフ`フント`ウ)
ヒツケ:2012.01.01
シコク: 08:15
オント`: 23.5 C
コ`サ:
      3 ppm

02
コウセイ(カ`イフ`フント`ウ)
DATE:2012.01.01
TIME: 10:05
TEMP: 22.4 C
DIFF:
      1 ppm

シュウリョウ
ヒツケ:2012.01.01
シコク: 12:03

ショメイ

*****
    
```

Appendix 4 Specifications

Appendix 4-1 Basic Specifications

Model	Gram (g)		Parts counting	Percentage	Pan size
	Max (g)	d (g)	Minimum unit weight (g)	Weight limit (g)	
LF124(R)	120	0.0001	0.0001	0.01	φ80
LF224(R)	220	0.0001	0.0001	0.01	
LF225DR	92 / 220	0.00001 / 0.0001	0.00001	0.001	
LF135R	135	0.00001	0.00001	0.001	

Appendix 4-2 Functional Specifications

Weighing system	Electromagnetic balance
Weighing mode	Simple weight measurement, Counting, Percentage weighing, Unit conversion and Gravimeter (only measures specific gravity of a solid)
Function	Automatic switch between two scale intervals (for LF225DR only), cumulate, net addition, limit function (5-level judgment based on upper- and lower-limit settings, judging by definite/deviation values), unit change, ISO/GLP/GMP, tare value save, calendar, clock, readability change, Se-CAL (Advice CAL and full automatic calibration), unit weight readout, gross weight readout, backlight duty selection, automatic backlight-off, Easy RES (single-touch response time change) and α -check (self-diagnosis function)
Display	LCD (with backlight) Maximum 8-digit 7-segment display, segment height up to 16.5 mm, 40-step bar graph display, and display of messages and symbols
Tare range setting	Single-touch tare range setting with an actual sample weight using the [Zero/Tare] key (Whether to wait for the balance to stabilize or not can be selected)
Zero tracking	Zero tracking can be disabled with a setting.
Display when overloaded	“o-Err” is displayed when the weighing capacity is exceeded by +9e (0.009 g).
Output	RS-232C compliant output is equipped as standard. SHINKO DENSHI standard format Type-B USB, D-SUB9P male (RS-232C output, external tare range setting port, bidirectional) Supported printer: CSP-160 II (SHINKO DENSHI)
Span adjustment	Functions selectable via settings Automatic span adjustment with internal weight (for LFR type only) Span adjustment with external weight (Use a weight that weighs 10% or more of the weighing capacity.) Entry of instrumental error of a weight to be used * Span adjustment is available in grams only.
Power	AC 100 to 240 V , DC 5.5V~6V
External dimensions (WDH)	210×320×335 mm (including the windshield)
Mass of the main unit	Approx. 5.5 kg
Operating temperature/humidity	Temperature: +10 to +30°C, Humidity: 80%rh or less (no condensation)
Options	Specific gravity measurement kit

Appendix 4-3 Weighing Capacity and Readability by Unit

Unit \ Model	LF124(R)	LF224(R)	LF225DR		LF135R
mg	120000	220000	92000	220000	130000
	0.1	0.1	0.01	0.1	0.01
gram (g)	120	220	92	220	130
	0.0001	0.0001	0.00001	0.0001	0.00001
carat (ct)	600	1100	460	1100	650
	0.0005	0.001	0.0001	0.001	0.0001
ounce (oz)	4.2	7.7	3.2	7.7	4.5
	0.000005	0.000005	0.000001	0.000005	0.000001
pound (lb)	0.26	0.48	0.2	0.48	0.28
	0.000001	0.000001	0.000001	0.000001	0.0000001
troy ounce (ozt)	3.8	7	2.9	7	4.1
	0.000005	0.000005	0.000001	0.000005	0.000001
penny weight (dwt)	77	140	59	140	83
	0.0001	0.0001	0.00001	0.0001	0.00001
grain (GN)	1800	3300	1400	3300	2000
	0.002	0.002	0.001	0.002	0.001
tael (tl) (Hong Kong)	3.2	5.8	2.4	5.8	3.4
	0.000005	0.000005	0.000001	0.000005	0.000001
tael (tl) (Singapore, Malaysia)	3.1	5.8	2.4	5.8	3.4
	0.000005	0.000005	0.000001	0.000005	0.000001
tael (tl) (Taiwan)	3.2	5.8	2.4	5.8	3.4
	0.000005	0.000005	0.000001	0.000005	0.000001
momme (mom)	32	58	24	58	34
	0.00005	0.00005	0.00001	0.00005	0.00001
tola (to)	10	18	7.8	18	11
	0.00001	0.00001	0.00001	0.00001	0.000001

Appendix 4-4 Unit Conversion Table

Unit	gram	carat	ounce	pound	troy ounce	penny weight
1g	1	5	0.03527	0.00220	0.03215	0.64301
1ct	0.2	1	0.00705	0.00044	0.00643	0.12860
1oz	28.34952	141.74762	1	0.06250	0.91146	18.22917
1lb	453.59237	2267.96185	16	1	14.58333	291.66667
1ozt	31.10348	155.51738	1.09714	0.06857	1	20
1dwt	1.55517	7.77587	0.05486	0.00343	0.05	1
1GN	0.06480	0.32399	0.00229	0.00014	0.00208	0.04167
1tl (Hong Kong)	37.429	187.145	1.32027	0.08252	1.20337	24.06741
1tl (SGP,Mal)	37.79936	188.99682	1.33333	0.08333	1.21528	24.30556
1tl (Taiwan)	37.5	187.5	1.32277	0.08267	1.20565	24.11306
1mom	3.75	18.75	0.13228	0.00827	0.12057	2.41131
1to	11.66380	58.31902	0.41143	0.02571	0.37500	7.5

Unit	grain	tael (Hong Kong)	tael (Singapore, Malaysia)	tael (Taiwan)	momme	tola
1g	15.43236	0.02672	0.02646	0.02667	0.26667	0.08574
1ct	3.08647	0.00534	0.00529	0.00533	0.05333	0.01715
1oz	437.5	0.75742	0.75	0.75599	7.55987	2.43056
1lb	7000	12.11874	12	12.09580	120.95797	38.88889
1ozt	480	0.83100	0.82286	0.82943	8.29426	2.66667
1dwt	24	0.04155	0.04114	0.04147	0.41471	0.13333
1GN	1	0.00173	0.00171	0.00173	0.01728	0.00556
1tl (Hong Kong)	577.61774	1	0.99020	0.99811	9.98107	3.20899
1tl (SGP,Mal)	583.33333	1.00990	1	1.00798	10.07983	3.24074
1tl (Taiwan)	578.71344	1.00190	0.99208	1	10	3.21507
1mom	57.87134	0.10019	0.09921	0.1	1	0.32151
1to	180	0.31162	0.30857	0.31103	3.11035	1

Appendix 4-5 Outline Drawings

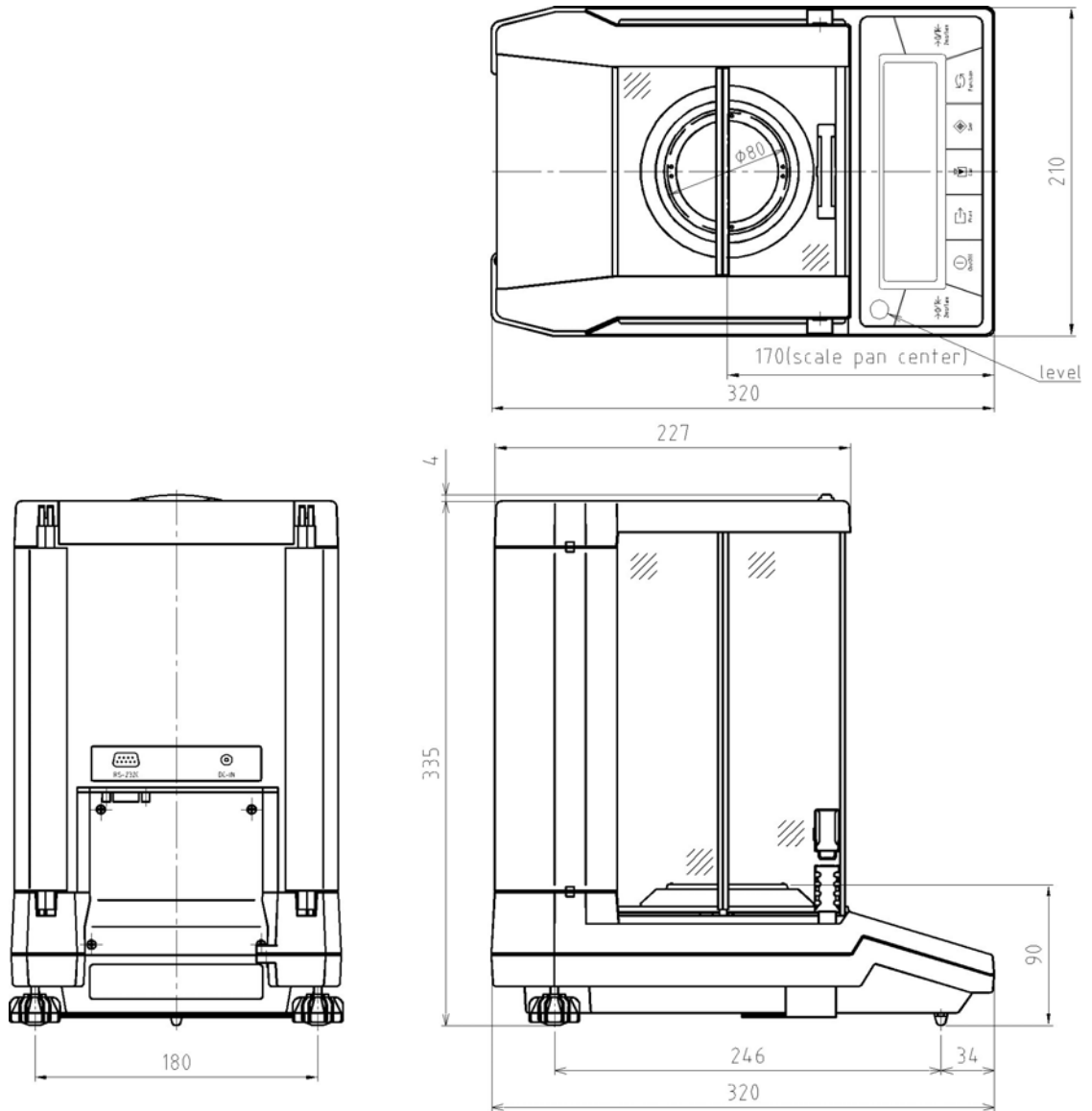

Index of Terms

[A]

α -check (self-diagnosis function)..... 83
 Addition function..... 37, 68
 Advice CAL 63
 Automatic backlight-off 74
 Automatic repeatability
 measurement 64, 87, 88
 Automatic switch between two scale
 intervals 71, 72
 Average sample weight 24

[B]

Bar graph 16, 42

[C]

Calibration 55
 Calibration of internal weight 59
 Carat 69
 Command..... 104
 Counting..... 24, 37, 40
 Cumulate..... 37

[D]

Definite value 42
 Deviation value..... 42, 47
 Display test..... 83
 D-SUB9P cable 89

[E]

Easy RES (single-touch response time
 change)..... 67

[F]

Full automatic calibration..... 63
 Function setting..... 21

[G]

Gravimeter 32, 68
 Gross..... 20

[H]

History 86

[I]

ID number 80
 Initialize 117
 Instrumental error 62

Interface 94
 Interval output function..... 78
 ISO/GLP/GMP compliant form 89

[J]

Judgment using definite values..... 45
 Judgment using deviation values 47

[K]

Key test..... 84

[L]

Limit function..... 40
 Limit value..... 42
 Liquid density 35
 Lower weight limit 29

[M]

Motor test..... 85

[N]

Net 20
 Net addition..... 37

[O]

Operation key 8

[P]

Percentage weighing 27, 37, 40
 Press and hold 9
 Printer 89

[R]

Readability 70
 Reference weight..... 29
 Repeatability measurement 64
 Response..... 110
 RS-232C 89, 91

[S]

Sample..... 24
 Se-CAL 63
 Semi-Automatic Repeatability
 Measurement 64, 65, 88
 Span adjustment 55, 57, 62, 80, 89
 Span test..... 56, 58, 62, 80, 89

Stability.....	81	Unit	69
Statistical operation function.....	49	Unit conversion	30, 37, 40
[T]		USB	93
Tare range setting	18, 73	[W]	
Terminator	105	Weighing capacity.....	18
Turning ON/OFF the automatic switch		Weight.....	55
between two scale intervals.....	72	Windshield door	13
[U]		[Z]	
Underfloor measurement.....	22	Zero-point adjustment.....	17

